

Computation of Some Parameters of Lie Geometries

A.E. Brouwer and A.M. Cohen

Centre for Mathematics and Computer Science
Kruislaan 413
1098 SJ Amsterdam
THE NETHERLANDS

Abstract

In this note we show how one may compute the parameters of a finite Lie geometry, and we give the results of such computations in the most interesting cases. We also prove a little lemma that is useful for showing that thick finite buildings do not have quotients which are (locally) Tits geometries of spherical type.

1. Introduction

The finite Lie geometries give rise to association schemes whose parameters are closely related to corresponding parameters of their associated Weyl groups. Though the parameters of the most common Lie geometries (such as projective spaces and polar spaces) are very well known, we have not come across a reference containing a listing of the corresponding parameters for geometries of Exceptional Lie type. Clearly, for the combinatorial study of these geometries the knowledge of these parameters is indispensable. The theorem in this paper provides a formula for those parameters of the association scheme that appear in the distance distribution diagram of the graph underlying the geometry. As a consequence of the theorem, we obtain a simple proof that the conditions in lemma 5 of [2] are fulfilled for the collinearity graph of any finite Lie geometry of type A_n , D_n , or E_m , $6 \leq m \leq 8$. (See remark 3 in section 4. The proof for the other spherical types, i.e. C_n , F_4 , and G_2 is similar.) By means of the formula in the theorem, we have computed the parameters of the Lie geometries in the most interesting open cases for diagrams with single bonds only (A_n and D_n are well known, and are given as examples). The remaining cases follow similarly, but the complete listing of all parameters would take too much space.

2. Introduction to Geometries (following Tits [10])

A *geometry* over a set Δ (the set of *types*) is a triple $(\Gamma, *, t)$ where Γ is a set (the set of *objects* of the geometry), $*$ is a symmetric relation on Γ (the *incidence* relation) and t is a mapping (the *type* mapping) from Γ into Δ , such that for $x, y \in \Gamma$ we have $(t(x)=t(y) \ \& \ x*y)$ if and only if $x=y$. (An example is provided by the collection Γ of all (nonempty proper) subspaces of a finite dimensional projective space, with $t: \Gamma \rightarrow \Delta = \mathbf{N}$, the rank function, and $*$ symmetrized inclusion (i.e., $x*y$ iff $x \subset y$ or $y \subset x$.)

Often we shall refer to the geometry as Γ rather than as $(\Gamma, *, t)$.

A *flag* is a collection of pairwise incident objects. The *residue* $\text{Res}(F)$ of a flag F is the set of all objects incident to each element of F . Together with the appropriate restrictions of $*$ and t , this set is again a geometry.

The *rank* of a geometry is the cardinality of the set of types Δ . The *corank* of a flag F is the cardinality of $\Delta \setminus t(F)$. A geometry is *connected* if and only if the (looped) graph $(\Gamma, *)$ is connected. A geometry is *residually connected* when for each flag of corank 1, $\text{Res}(F)$ is nonempty, and for each flag of corank at least 2, $\text{Res}(F)$ is nonempty and connected.

A (*Buekenhout-Tits*) *diagram* is a picture (graph) with a node for each element of Δ and with labelled edges. It describes in a compact way a set of axioms for a geometry Γ with set of types Δ as follows: whenever an edge $(d_1 d_2)$ is labelled with D , where D is a class of rank 2 geometries, then each residue of type $\{d_1, d_2\}$ of Γ must be a member of D . (Notice that a residue of type $\{d_1, d_2\}$ is the residue of a flag of type $\Delta \setminus \{d_1, d_2\}$.) In the following we need only two classes of rank 2 geometries. The first is the class of all projective planes, indicated in the diagram by a plain edge. The second is the class of all generalized digons, that is, geometries with objects of two types such that each object of one type is incident with every object of the other type. Generalized digons are indicated in the diagram by an invisible (i.e., absent) edge.

For example, the diagram

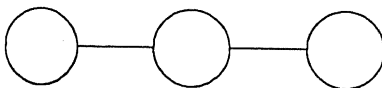

is an axiom system characterizing the geometry of points, lines, and planes of projective 3-space. Note that the residue of a line (i.e., the points on the line and the planes containing the line) is a generalized digon. Usually, one chooses one element of Δ and calls the objects of this type *points*. The residues of this type are called *lines*. Thus lines are geometries of rank 1, but all that matters is they constitute subsets of the point set. In the diagram the node corresponding to the points is encircled.

As an example, the principle of duality in projective 3-space asserts the isomorphism of the geometries

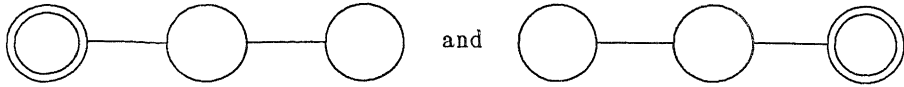

Grassmannians are geometries like

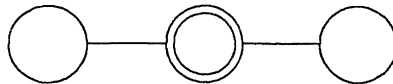

(Warning: points are objects of the geometry but lines are sets of points, and given a line, there need not be an object in the geometry incident with the same set of points.)

Let us write down some diagrams (with nodes labelled by the elements of Δ) for later reference.

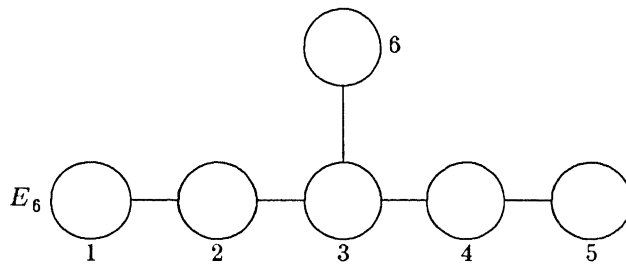
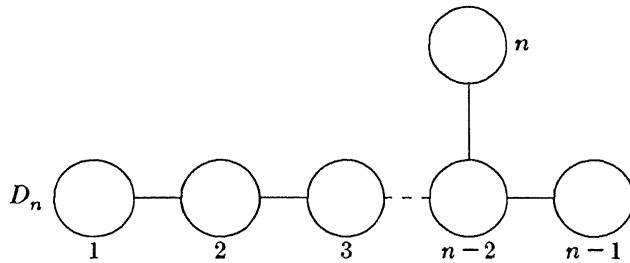
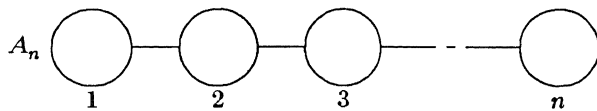

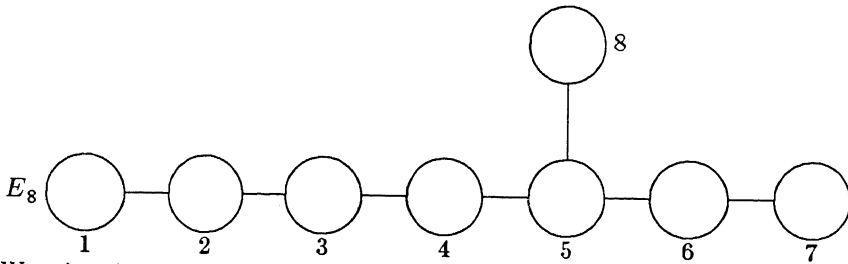
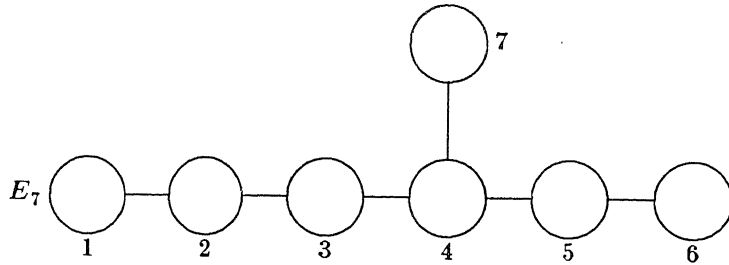

(Warning: in different papers different labellings of these diagrams are used.)

If one wants to indicate the type corresponding to the points, it is added as a subscript. For example, $D_{4,1}$ denotes a geometry belonging to the diagram

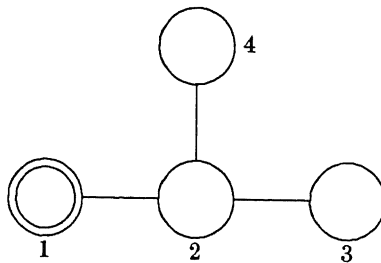

It is possible to prove that if Γ is a finite residually connected geometry of rank at least 3 belonging to one of these diagrams having at least three points on each line then the number of points on each line is $q+1$ for some prime power q , and given a prime power q there is a unique geometry with given diagram and $q+1$ points on each line. We write $X_n(q)$ for this unique geometry, where X_n is the name of the diagram (cf. Tits [9] Chapter 6, and [2]).

[For example, $A_n(q)$ is the geometry of the proper nonempty subspaces of the projective space $\text{PG}(n, q)$. Similarly, $D_n(q)$ is the geometry of the nonempty totally isotropic subspaces in $\text{PG}(2n-1, q)$ supplied with a nondegenerate quadratic form of maximal Witt index. Finally, $D_{n,1}(q)$ is an example of a polar space.]

A remark on notation: ‘:=’ means “is by definition equal to” or “is defined as”.

3. Distance Distribution Diagrams for Association Schemes

An *association scheme* is a pair $(X, \{R_0, \dots, R_s\})$ where X is a set and the R_i ($0 \leq i \leq s$) are relations on X such that $\{R_0, \dots, R_s\}$ is a partition of $X \times X$ satisfying the following requirements:

- (i) $R_0 = I$, the identity relation.
- (ii) for all i , there exists an i' such that $R_i^T = R_{i'}$.
- (iii) Given $x, y \in X$ with $(x, y) \in R_i$, then the number $p_{jk}^i = |\{z: (x, z) \in R_j \text{ and } (y, z) \in R_k\}|$ does not depend on x and y but only on i .

Usually we shall write v for the total number of points of the associated scheme, i.e. $v = |X|$. The obvious example of an association scheme is the situation where a group G acts transitively on a set X . In this case one takes for $\{R_0, \dots, R_s\}$ the partition of $X \times X$ into G -orbits, and requirements (i)-(iii) are easily verified.

Assume that we have an association scheme with a fixed symmetric nonidentity relation R_1 (i.e., $R_1^T = R_1$). Clearly (X, R_1) is a graph. Now one may draw a diagram displaying the parameters of this graph by drawing a circle for each relation R_i , writing the number $k_i = |\{z: (x, z) \in R_i\}| = p_{ii}^0$ where $x \in X$ is arbitrary inside the circle, and joining the circles for R_i and R_j by a line carrying the number p_{j1}^i at the (R_i) -end whenever $p_{j1}^i \neq 0$. (Note that $k_i p_{j1}^i = k_j p_{i1}^j$ so that p_{j1}^i is nonzero iff p_{i1}^j is nonzero.) When $i = j$, one usually omits the line and just writes the number p_{i1}^i next to the circle for R_i .

For example, the Petersen graph becomes a symmetric association scheme, i.e., one for which $R_i^T = R_i$ for all i when we define $(x, y) \in R_i$ iff $d(x, y) = i$ for $i=0,1,2$. We find the diagram

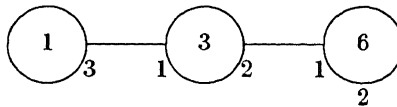

More generally, a graph is called *distance regular* when $(x, y) \in R_i$ iff $d(x, y) = i$ ($0 \leq i \leq \text{diam}(G)$) defines an association scheme.

When (X, R_1) is a distance regular graph, or, more generally, when the matrices I, A, A^2, \dots, A^s are linearly independent (where A is the 0-1 matrix of R_1 , i.e., the adjacency matrix of the graph), then the p_{j1}^i suffice to determine all p_{jk}^i . On the other hand, when the association scheme is not symmetric but R_1 is, then clearly not all R_j can be expressed in terms of R_1 .

In this note our aim is to compute the parameters p_{jk}^i for the Lie geometries $X_{m,n}(q)$ where X_m is a (spherical) diagram with designated 'point'-type n , and the association scheme structure is given by the group of (type preserving) automorphisms of $X_{m,n}(q)$ - essentially a Chevalley group. In the next section we shall give formulas valid for all Chevalley groups and in the appendix we list results in some of the more interesting cases. Let us do some examples explicitly. (References to words in the Weyl group will be explained in the next section.)

Usually we give only the p_{j1}^i ; the general case follows in a similar way.

Example 1.

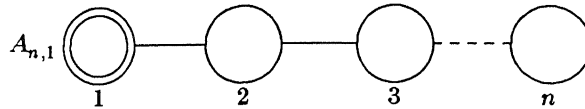

The collinearity graph of points in a projective space is a clique: any two points are adjacent (collinear). Thus our diagram becomes

$$v = \frac{q^{n+1}-1}{q-1}, k = \frac{q^n-1}{q-1} q = v-1.$$

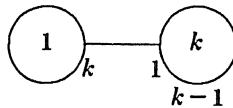

Example 2.

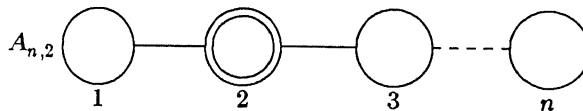

Now we have the graph of the projective lines in a projective space, two projective lines being adjacent whenever they are in a common plane (and have a projective point in common).

[N.B.: the lines of this geometry are pencils of $q+1$ projective lines in a common plane and on a common projective point.]

Our diagram becomes

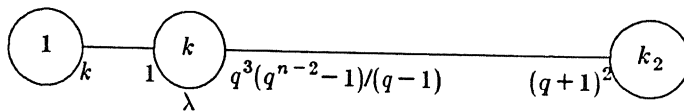

Weyl words: "" "2" "2312"

$$v = \frac{(q^{n+1}-1)(q^n-1)}{(q^2-1)(q-1)}$$

$$k = q(q+1) \frac{q^{n-1}-1}{q-1}$$

$$\lambda = q-1 + q^2 + q^2 \frac{q^{n-2}-1}{q-1}$$

$$k_2 = \frac{q^{n-1}-1}{q^2-1} \frac{q^{n-2}-1}{q-1} q^4$$

For $q=1$ (the ‘thin’ case) this becomes the diagram for the triangular graph:

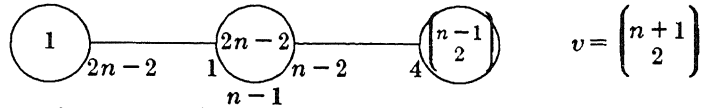

[Clearly $\lambda_i := p_{1i}^i = k - \sum_{j \neq i} p_{1j}^i$. Often, when λ_i does not have a particularly nice form, we omit this redundant information.]

Notice how easily the expressions for v, k, k_2, λ can be read off from the Buckenhout-Tits diagram: for example, $\lambda = \lambda(x, y)$ first counts the $q-1$ points on the line xy , then the remaining q^2 points of the unique plane of type $\{1, 2\}$ containing this line and finally the remaining q^2 points of the planes of type $\{2, 3\}$ containing this line.

Example 3.

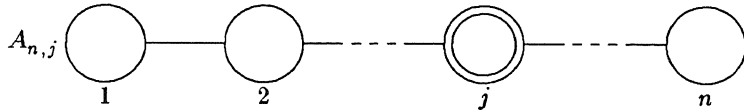

This is the graph of the j -flats (subspaces of dimension j) in projective n -space, two j -flats being adjacent whenever they are in a common $(j+1)$ -flat (and have a $(j-1)$ -flat in common). The graph is distance regular with diameter $\min(j, n+1-j)$. Parameters are

$$v = \frac{(q^{n+1}-1)(q^n-1)\dots(q^{n+2-j}-1)}{(q^j-1)(q^{j-1}-1)\dots(q-1)} =: \begin{bmatrix} n+1 \\ j \end{bmatrix}_q$$

$$k = q^{i^2} \begin{bmatrix} j \\ i \end{bmatrix}_q \begin{bmatrix} n-j+1 \\ i \end{bmatrix}_q$$

$$b_i := p_{1,i+1}^i = q^{2i+1} \begin{bmatrix} j-i \\ 1 \end{bmatrix}_q \begin{bmatrix} n-j-i+1 \\ 1 \end{bmatrix}_q$$

$$c_i := p_{1,i-1}^i = \begin{bmatrix} i \\ 1 \end{bmatrix}_q^2$$

The parameters for the thin case have $q=1$ and binomial instead of Gaussian coefficients; we find the Johnson scheme $\begin{bmatrix} n+1 \\ j \end{bmatrix}$.

The Weyl words (minimal double coset representatives in the Weyl group) have the following shape: for double coset i in $A_{n,j}$ the representative is

$$w_i := "j, j+1, \dots, j+i-1, j-1, j, \dots, j+i-2, \dots, j-i+1, j-i+2, \dots, j"$$

Note that w_i has length i^2 , the power of q occurring in k_i .

Example 4.

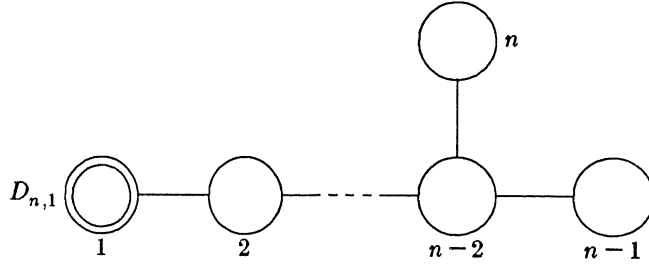

($n \geq 3$; $D_{2,1}$ is the direct product $A_{1,1} \times A_{1,1}$, i.e., a $(q+1) \times (q+1)$ grid.)

$$v = \#D_{n,1} = \frac{(q^n - 1)(q^{n-1} + 1)}{q - 1}$$

$$k = q \#D_{n-1,1} = q \frac{(q^{n-1} - 1)(q^{n-2} + 1)}{q - 1}$$

Diagram:

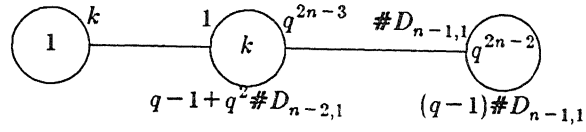

Thin case:

$$v = 2n, k = 2n - 2$$

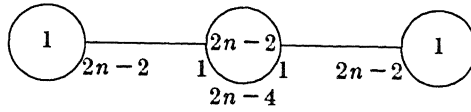

This is K_{2n} minus a complete matching.

The Weyl words are:

“” for double coset 0,

“1” for double coset 1, and

“1 2 3 \cdots $n-3$ $n-2$ n $n-1$ $n-2$ \cdots 1” for double coset 2.

Example 5.

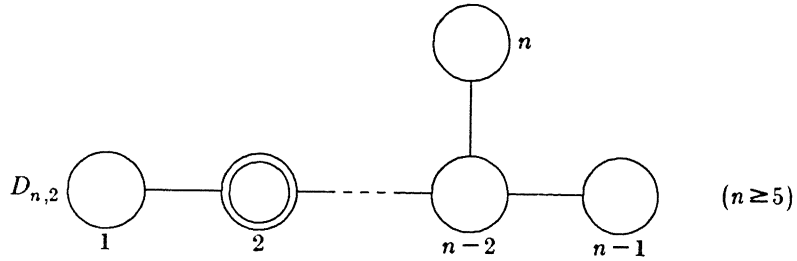

$$v = \frac{\#D_{n,1}\#D_{n-1,1}}{\#A_{1,1}} = \frac{(q^n - 1)(q^{n-1} + 1)(q^{n-1} - 1)(q^{n-2} + 1)}{(q^2 - 1)(q - 1)}$$

$$k = q\#A_{1,1}\#D_{n-2,1} = q(q + 1) \frac{(q^{n-2} - 1)(q^{n-3} + 1)}{q - 1}$$

Diagram (for $n > 4$):

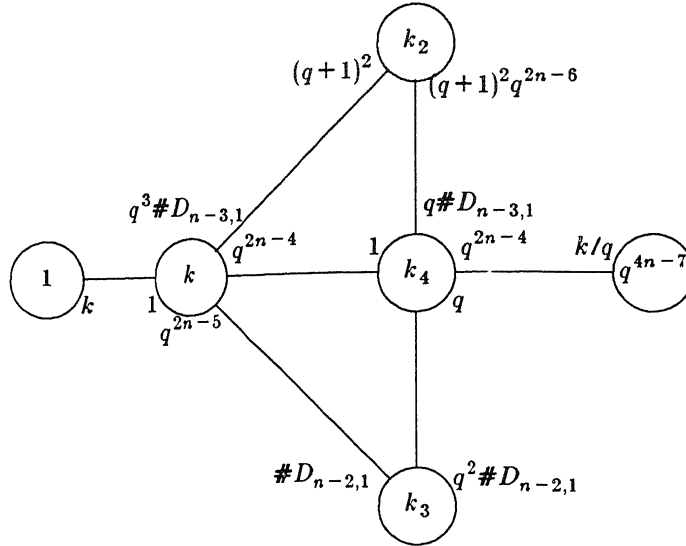

Double coset 1 contains adjacent points, i.e., lines of the polar space in a common plane. Shortest path in the geometry: 2-3-2 (unique).

Double coset 2 contains the points at 'polar' distance two, belonging to the Weyl word "2312", i.e., in a polar space $A_{3,2}$. (I.e., lines of the polar space in a common t.i. subspace). Thus

$$k_2 = \#D_{n-2,2}k_2(A_{3,2}) = \frac{q^{2n-6}-1}{q^2-1} \frac{q^{n-2}-1}{q-1} (q^{n-4}+1)q^4$$

Shortest path in the geometry: 2-4-2 (unique). Double coset 3 contains points incident with a common 1-object, so that the Weyl word is the one for double coset 2 in $D_{n-1,1}$ (relabelled):

$$"2\ 3\ \cdots\ n-3\ n-2\ n\ n-1\ n-2\ \cdots\ 2"$$

(These are intersecting lines not in a common t.i. plane.) Thus

$$k_3 = \#A_{1,1}k_2(D_{n-1,1}) = (q+1)q^{2n-4}$$

Shortest path in the geometry: 2-1-2 (unique).

Double coset 4 contains points with shortest path 2-1-3-2 (unique); the Weyl word is

$$"2\ 3\ \cdots\ n-3\ n-2\ n\ n-1\ n-2\ \cdots\ 3\ 1\ 2"$$

the reduced form of the product of the word we found for double coset 3 and the word "212" describing adjacency in $A_{2,2}$. Thus

$$k_4 = \#D_{n-2,1}q^2(\#D_{n-1,1} - (q+1) - q^2\#D_{n-3,1}) = \frac{q^{n-2}-1}{q-1}(q^{n-3}+1)(q+1)q^{2n-3}.$$

Double coset 5 contains the remaining q^{4n-7} points (the lines of the polar space in general position). Shortest path in the geometry: 2-1-2-1-2 (not unique). The Weyl word is

$$"2\ 3\ \cdots\ n-1\ 1\ 2\ 3\ \cdots\ n-2\ n\ n-2\ \cdots\ 2\ 1\ n-1\ \cdots\ 3\ 2"$$

of length $4n-7$.

The thin case is:

$$v = 2n(n-1), \quad k = 4(n-2)$$

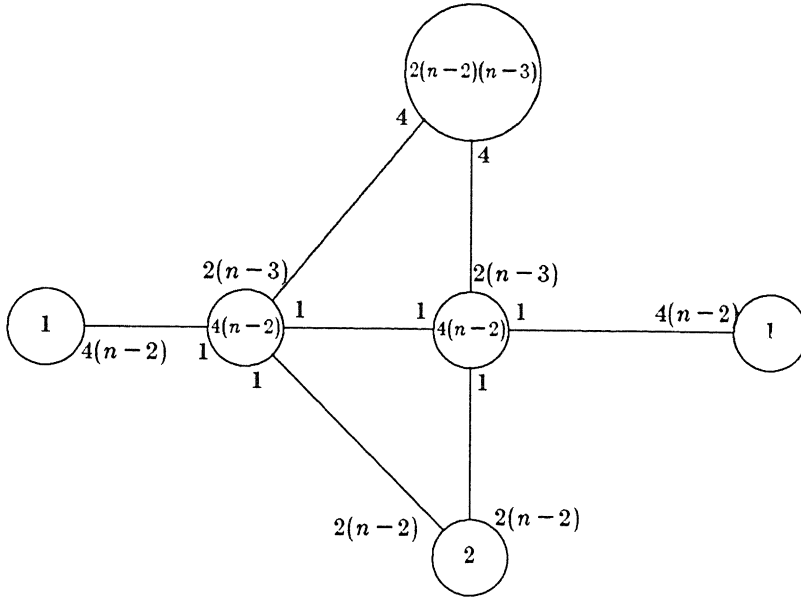

Example 6.

Double coset	Weyl word	Cardinality	Shortest path (unique)
0	""	1	2
1	"2"	$q(q+1)^3$	2- $\{1,3,4\}$ -2
2	"2312"	$q^4(q+1)$	2-4-2
3	"2412"	$q^4(q+1)$	2-3-2
4	"2432"	$q^4(q+1)$	2-1-2
5	"24312"	$q^5(q+1)^3$	2-1- $\{3,4\}$ -2
6	"231242132"	q^9	

Diagram:

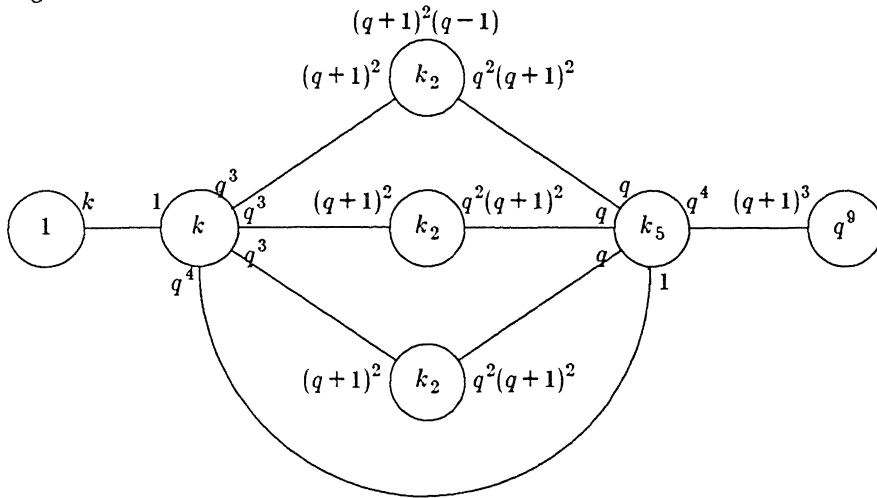

Example 7.

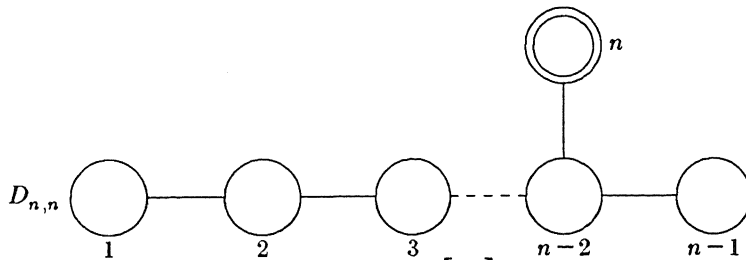

This graph is distance regular of diameter $\left\lfloor \frac{n}{2} \right\rfloor$.

We have

$$v = (q^{n-1} + 1)(q^{n-2} + 1) \dots (q + 1)$$

$$k = q \begin{bmatrix} n \\ 2 \end{bmatrix}_q$$

$$k_i = q \binom{2i}{2} \begin{bmatrix} n \\ 2i \end{bmatrix}_q$$

$$b_i = q^{4i+1} \begin{bmatrix} n-2i \\ 2 \end{bmatrix}_q$$

$$c_i = \begin{bmatrix} 2i \\ 2 \end{bmatrix}_q$$

Note that when $n = 2m$, then $k_m = q^{m(2m-1)}$. Also, note that in the case $n = 4$ these parameters reduce to those we found for $D_{4,1}$.

Two points have distance $\leq i$ (for $0 \leq i \leq n$) iff there is a path $n - (n - 2i) - n$ in the geometry. When n is even, then two points at distance $\frac{n}{2}$ ("in general position") are not incident to a common object. (Note that $k = \#A_{n-1,2}q$ and, more generally, that

$$k_i = \#A_{n-1,2i} k_i(D_{2i,2i}) = q^{i(2i-1)} \#A_{n-1,2i}.$$

The values for b_i and c_i follow similarly. The value for v follows by induction, and when $n = 2m$ then k_m is found from $k_m = v - \sum_{i < m} k_i$.)

The Weyl word corresponding to distance i is the same one (after relabelling) as in $D_{2i,2i}$, namely:

$$"n \ n-2 \ n-1 \ n-3 \ n-2 \ n \ n-4 \ n-3 \ n-2 \ n-1 \ \dots"$$

of length

$$1 + 2 + 3 + 4 + \dots + 2i - 1 = i(2i - 1).$$

In the thin case we have $v = 2^{n-1}$, $k = \begin{bmatrix} n \\ 2 \end{bmatrix}$, and the graph is that of the binary vectors of even weight and length n where the distance is the Johnson distance, i.e., half the Hamming distance.

Example 8 (see Tits [8]).

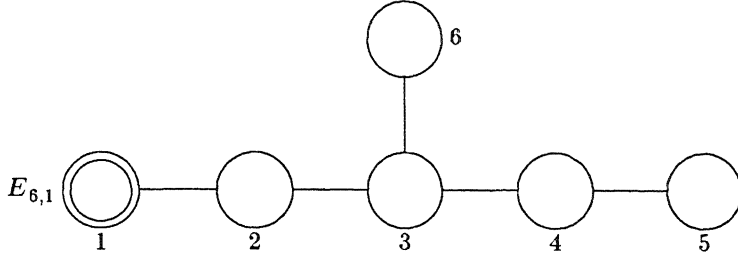

This graph is strongly regular (i.e., distance regular with diameter 2). We have

$$v = \frac{q^{12}-1}{q^4-1} \frac{q^9-1}{q-1}$$

and

$$k = q \# D_{5,5} = q \frac{q^8-1}{q-1} (q^3+1).$$

The thin case gives diagram

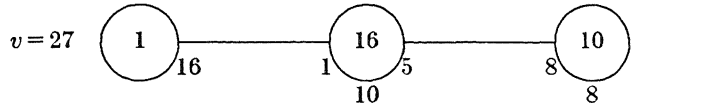

the Schläfli graph; this is the complement of the collinearity graph of the generalized quadrangle $GQ(2,4)$. In general we find the diagram

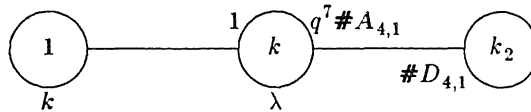

where $k_2 = q^8 \# D_{5,1}$ and $\lambda = q-1 + q^2 \# A_{4,2}$.

Double coset 1 corresponds to the shortest path 1-2-1 and has Weyl word "1". Double coset 2 corresponds to the shortest path 1-5-1 and has Weyl word "12364321", as in $D_{5,1}$.

Example 9.

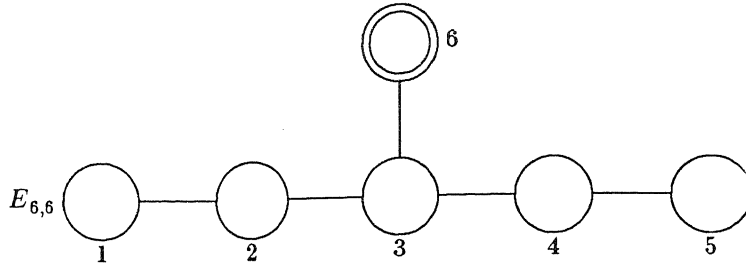

This graph has

$$v = \frac{q^9 - 1}{q - 1} (q^6 + 1)(q^4 + 1)(q^3 + 1)$$

and

$$k = q \# A_{5,3} = q(q^2 + 1)(q^3 + 1) \frac{q^5 - 1}{q - 1}$$

The thin case gives diagram

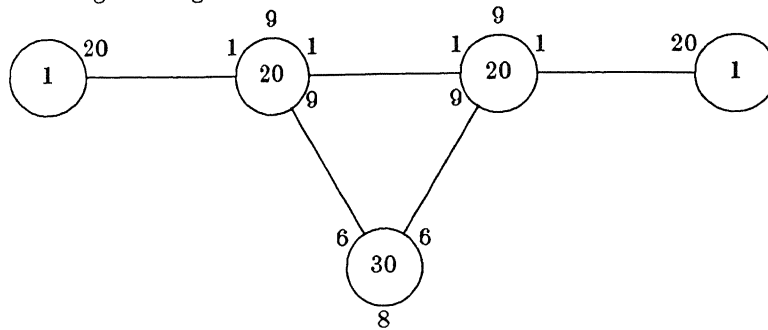

with $v = 72$.

In general we find

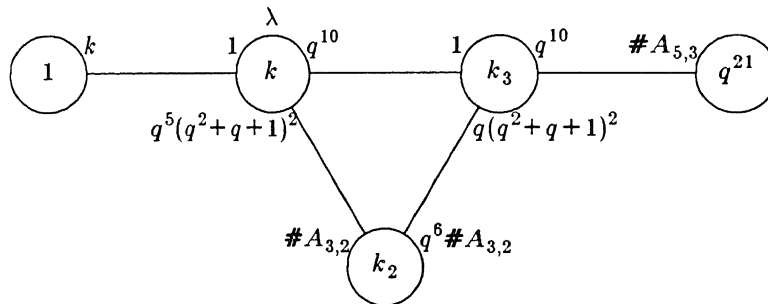

with $k_2 = \# A_{5,1} \# A_{4,1} q^6$ and $k_3 = q^{10} k$ and $\lambda = q - 1 + q^2 (q^2 + q + 1)^2$. Double coset 1 corresponds to shortest path 6-3-6 and has Weyl word "6". Double coset 2 corresponds to shortest path 6- $\{1,5\}$ -6 and has Weyl word "634236" (of $D_{4,1}$).

Double coset 3 corresponds to shortest path 6-1-4-6 (or, equivalently, 6-5-2-6) and has Weyl word "6345 234 1236". Double coset 4 has Weyl word "6345 234 1236345 234 1236".

Example 10.

The case of type $F_{4,1}$ has been treated in Cohen [6].

Up to now all our computations were easy and straightforward, mainly because of the limited permutation ranks (number of classes of these association schemes) and the fact that $A_{n,1}$, $D_{n,1}$, and $E_{6,1}$ have diameter at most two. Continuing in this vein we quickly encounter difficulties. $E_{7,1}$ is still distance regular with diameter three and $E_{7,6}$ and $E_{8,1}$ have diagrams like $E_{6,6}$ (and these three cases are easily done by hand) but for instance $E_{7,4}$ has 149 classes (double cosets) and all geometric intuition is lost; in the next section we describe how parameters for these Lie geometries can be mechanically derived by means of some computations in the Weyl group. In a way, this means that it suffices to consider the case $q=1$. Now everything is finite and a computer can do the work.

In the appendix we give computer output describing $E_{7,1}$, $E_{7,6}$, $E_{7,7}$, $E_{8,1}$, $E_{8,7}$, and $E_{8,8}$, in other words, the geometries belonging to the 'end nodes' of the diagrams E_7 and E_8 . For E_7 we also computed the parameters on the remaining nodes, but listing these would take too much room. We therefore content ourselves with the presentation of the permutation ranks for the Chevalley groups of type F_4 , E_n ($6 \leq n \leq 8$); to each node r in the diagram below is attached the permutation rank of the Chevalley group of the relevant type on the maximal parabolic corresponding to r .

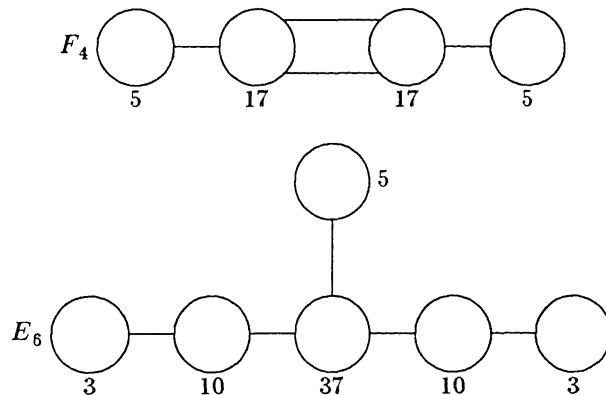

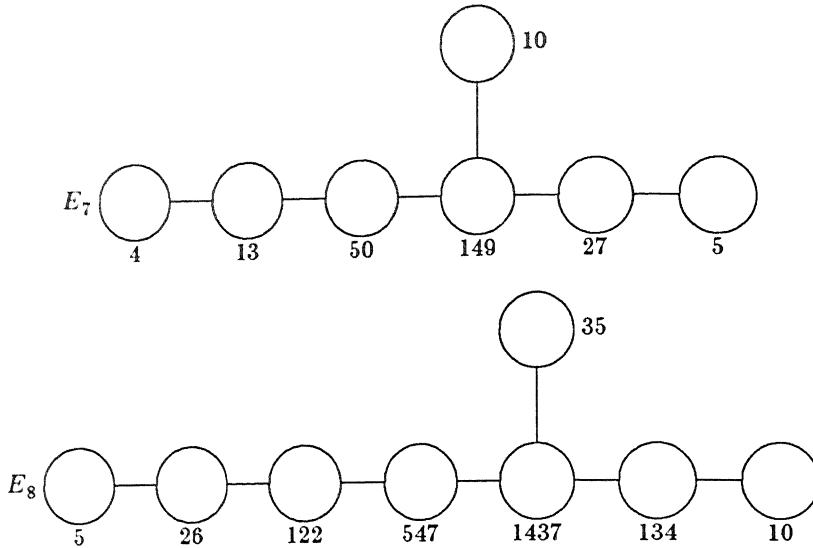

4. Reduction to the Weyl group

In this section, G is a Chevalley group $X_n(q)$ of type X_n over a finite field \mathbf{F}_q . We shall rely heavily on Carter [4], to which the reader is referred for details. Though with a little more care, all statements can be adapted so that they are also valid for twisted Chevalley groups, for the sake of simplicity, we shall only consider the case of an untwisted Chevalley group G . To G we can associate a split saturated Tits system (B, N, W, R) , cf. Bourbaki [1], consisting of subgroups B, N of G such that G is generated by them, and of a Coxeter system (W, R) with the following properties:

- (i) $H = B \cap N$ is a normal subgroup of N and $W = N/H$.
- (ii) For any $w \in W$ and $r \in R$,

$$(ii)' \quad BwBrB \subset BwBUBwrB$$

$$(ii)'' \quad {}^r B \subset B$$

- (iii) (split) There is a normal subgroup U of B with $B = UH$ and $U \cap H = \{1\}$.

- (iv) (saturated) $\bigcap_{w \in W} {}^w B = H$.

Here and below, ${}^w A$ stands for wAw^{-1} if A is a subset of G invariant under conjugation by H . Notice that ${}^w B$ and Bw are well defined. We shall briefly recall how a Tits system may be obtained. Start with a Coxeter system (W, R) where W is a Weyl group of type X_n . Let Φ be a root system for W . A set of

mutually obtuse roots corresponding to the subset R (of *fundamental reflections*) forms a set of *fundamental roots*. Now any root $\alpha \in \Phi$ is an integral linear combination of the fundamental roots such that either all coefficients are nonnegative or all coefficients are nonpositive. In the former case, α is called *positive*, denoted $\alpha > 0$; in the latter case, α is called *negative*, denoted $\alpha < 0$.

Now choose a Cartan subgroup H in G , and denote by X_α for $\alpha \in \Phi$ the root subgroup with respect to α (viewed as a linear character of H). Thus H normalizes each X_α . Next, let N be the normalizer of H in G . Then $W = N/H$ permutes the X_α ($\alpha \in \Phi$) according to ${}^w X_\alpha = X_{w\alpha}$ ($w \in W$).

Now $U = \prod_{\alpha > 0} X_\alpha$ is a subgroup of G normalized by H , so that $B = UH$ is a subgroup of G with $B \cap N = H$. This explains how B, N, W, R, U occur in G . We need some more subgroups of G . Given $w \in W$, set

$$U_w^- := \prod_{\alpha > 0, w^{-1}\alpha < 0} X_\alpha.$$

It is of crucial importance to the computations below that

$$|U_w^-| = q^{l(w)}$$

for every $w \in W$, where $l(w)$ denotes the length of w with respect to R . (For a proof, see Carter [4] 8.6; notice that our definition of U_w^- differs from Carter's in that our U_w^- coincides with his $U_{w^{-1}}$.) Observe that U_w^- is a subgroup of U , for if we let w_0 denote the unique longest element in W with respect to l , then w_0 is an involution satisfying $U_w^- = U \cap {}^{w_0}U$ (and also $U \cap {}^{w_0}U = \{1\}$). Fix $r \in R$ and write $J = R \setminus \{r\}$, $W_J = \langle J \rangle$, the subgroup of W generated by J , and $P = BW_JB$. Then P is a so-called maximal parabolic subgroup of G (associated with r). We are interested in the graph $\Gamma = \Gamma(G, P)$ defined as follows. Its vertices are the cosets xP in G (for $x \in G$), two vertices xP, yP being adjacent when $y^{-1}x \in PrP$.

In this graph, xP and yP have distance $d(xP, yP) \leq e$ if and only if $y^{-1}x \in P \langle r \rangle \cdots \langle r \rangle P$ (a product of $2e+1$ terms). Let us first compute the number v of vertices of this graph.

Lemma 1. Each coset xP has a unique representation $xP = uwP$ where $u \in U_w^-$ and w is a right J -reduced element of W , i.e.,

$$w \in L_J := \{w \in W \mid l(ww') \geq l(w) \text{ for all } w' \in W_J\}.$$

Proof:

xB has a (unique) representation $xB = uwB$ with $w \in W$, $u \in U_w^-$ (see Carter [4], Theorem 8.4.3). Thus $xP = uwP$ and obviously we may take $w \in L_J$ (cf. Bourbaki [1], Chap. IV, §1 Exercice 3). Suppose $uwP = u'w'P$. Then $w' \in BwBW_JB$ so that $w' = ww''$ with $w'' \in W_J$, but since $w, w' \in L_J$ it follows that

$w'=w$. We assert that $P \cap w^{-1}Bw \subset B$. (See [5], Proposition p. 63; since this reference is not easily accessible we repeat the argument.) Let $w = r_1 r_2 \cdots r_t$ be an expression of w as a product of $t=l(w)$ reflections in R . Denote by S the set of elements of the form $r_{i_1} r_{i_2} \cdots r_{i_s}$ with $i_1 < i_2 < \cdots < i_s$. Then $W_J \cap S^{-1}w = \{1\}$ since $wW_J \cap S = \{w\}$ (w is the only element in S with length at least $l(w)$). Hence, $P \cap w^{-1}Bw \subset BW_J B \cap Bw^{-1}BwB \subset BW_J B \cap BS^{-1}wB = B(W_J \cap S^{-1}w)B = B$, as asserted. Now $u^{-1}u' \in wPw^{-1} \cap U_w^- = w(P \cap w^{-1}Uw \cap w_0 U w_0^{-1})w^{-1} \subset w(B \cap w_0 U w_0^{-1})w^{-1} = \{w w^{-1}\} = \{1\}$ since $B \cap w_0 U = 1$ (see Carter [4], Lemma 7.1.2). Thus $u = u'$. •

Proposition 1. The graph $\Gamma(G, P)$ has v vertices, where

$$v = \sum_{w \in L_J} q^{l(w)}.$$

Proof:

A straightforward consequence of the formula $|U_w^-| = q^{l(w)}$ for $w \in W$ and lemma 1. •

Remark 1. Of course, we also have the multiplicative formula

$$v = |G/P| = \prod_{i=1}^n \frac{q^{d_i} - 1}{q^{e_i} - 1}$$

where d_1, \dots, d_n are the degrees of the Weyl group W , e_2, \dots, e_n are the degrees of the Weyl group W_J and $e_1 = 1$ (cf. Carter [4]).

Next, we want to put the structure of an association scheme on this graph. The group G acts by left multiplication on the cosets xP , and clearly this action is transitive. Thus we find an association scheme. The collections of cosets in a fixed relation with a given coset, say P , are the double cosets PxP . The pair (xP, yP) has relation $G(xP, yP)$, labelled with $Px^{-1}yP$. We see that a relation PxP is symmetric iff $PxP = Px^{-1}P$, and this holds in particular for $x = r$.

Lemma 2. Each double coset PxP has a unique representation $PxP = PwP$ where w is an element of W that is both left and right J -reduced, i.e.,

$$w \in D_J := \{w \in W \mid w \text{ is the unique shortest word of } W_J w W_J\}.$$

Proof:

See Bourbaki [1] Chap. IV §1 Exercice 3. •

Proposition 2. The association scheme $\Gamma(G, P)$ has valencies k_i (belonging to the relation PiP) for $i \in D_J$, where

$$k_i = \sum_{w \in L_J \cap W_J i} q^{l(w)}.$$

Proof:

Obvious. ●

Remark 2. If $i \in D_J$, then $iW_J i^{-1} \cap W_J = W_{iJ_i^{-1} \cap J}$ by Solomon [7], so substitution of $q=1$ in the above formula for k_i leads to the equation. $|L_J \cap W_J i| = \frac{|W_J|}{|W_{iJ_i^{-1} \cap J}|}$.

Finally, we come to the parameters p_{jk}^i . It is more convenient to label the relations (such as i, j, k) by elements from D_J than by $0, 1, \dots, s$ as in Section 2. Therefore, we shall use these new labels; 1 now stands for the "old 0", and r for adjacency, i.e., the "old 1". We shall confine ourselves to giving p_{jr}^i .

Theorem. Let $i, j \in D_J$. Then the number of points (i.e., cosets) in $iPrP \cap PjP$ is

$$p_{jr}^i = \sum_{w \in L \cap A, l(iw) > l(iwr)} q^{l(w)+} + \sum_{w \in L \cap A, l(iw) < l(iwr)} q^{l(wr)+} + \sum_{w \in L \cap Ar, l(iw) < l(iwr)} q^{l(wr)}(q-1)$$

where $L := L_J \cap W_J r$ and $A := i^{-1}W_J j W_J$.

Proof:

Clearly,

$$W_J j W_J = \bigcup_{w \in L} w W_J$$

Consequently,

$$iPrP = iB W_J B r B W_J B = iB W_J r W_J B = \bigcup_{w \in L} iB w P$$

Now we want to write each set $iB w P$ as a union of cosets uwP as in lemma 1. For $g \in G$ and K a subgroup of G define ${}^g K := gKg^{-1}$ and $K^\# = K \setminus \{1\}$. It is well known that for any $u \in W$ we have if $l(iu) = l(i) + l(u)$ then ${}^i(U_u^-) \subseteq U_{iu}^-$. (See Cohen [5] Lemma 2.11.) Notice that $w = vr$ for some $v \in W_J$ with $l(iv) = l(i) + l(v)$ and $l(vr) = l(v) + 1$.

Distinguish two cases:

If $l(iw) > l(iv)$ then

$$iB w B = iU_w^- w B = {}^i(U_w^-) i w B$$

and we have ${}^i(U_w^-) \subseteq U_{iw}^-$ as desired.

If $l(iw) < l(iv)$ then

$$iBwB = iBvBrB = {}^i(U_v^-)ivBrB = {}^i(U_v^-) \cdot (iwB \dot{\cup} {}^{iw}((U_r^-)^\#)ivB)$$

and we have ${}^i(U_v^-) \subseteq U_{iw}^-$, ${}^i(U_v^-) \cdot {}^{iw}(U_r^-) \subset U_{iv}^-$ as desired. (For the inclusion ${}^i(U_v^-) \subseteq U_{iw}^-$ note that v cannot change the sign of the root corresponding to r since $v \in W_J$.)

Now in order to count how many of the cosets uwP fall into a given double coset PjP we need only observe that $uwP \subseteq PjP$ iff $w \in W_J j W_J$, and that distinct $w \in L$ lead to distinct cosets iwP . ●

Corollary. Given two vertices x_1P, x_2P of Γ at mutual distance d , the number of vertices at distance $d-1$ to x_1P and adjacent to x_2P is congruent to $1 \pmod{q}$, and the number of vertices at distance d to x_1P and adjacent to x_2P is congruent to $-1 \pmod{q}$. Also, the valency k is congruent to $0 \pmod{q}$.

Proof:

From " $w \in W_J r$ iff $l(w) \geq 1$ " and the expression given for $k = k_r$ we see that $k \equiv 0 \pmod{q}$. Next, from the previous theorem we obtain that

$$p_{jr}^i = \delta(ir \in W_J j W_J) + (q-1) \cdot \delta(i \in W_J j W_J) \pmod{q}$$

where $\delta(T)$ for a predicate T denotes 1 if T is true and 0 otherwise. Thus, all p_{jr}^i are congruent to $0 \pmod{q}$ except p_{ir}^i which is congruent to $-1 \pmod{q}$ and $p_{ir}^{\bar{i}}$ which is congruent to $1 \pmod{q}$ -- where \bar{i} is defined by $ir \in W_J \bar{i} W_J$. Clearly $d(P, \bar{i}P) = d(P, iP) - 1$. ●

Remark 3. This corollary is motivated by Lemma 5 in [2] which is a crucial step in the proof that if Γ is finite and $q > 1$, then the building corresponding to the Tits system (B, N, W, R) does not have proper quotients satisfying the conditions in [10], Theorem 1. The above corollary shows that the conditions are satisfied for the Chevalley groups of type A_n, D_n or E_m ($6 \leq m \leq 8$). For another application, see [3].

Remark 4. It is possible to compute the parameters p_{jk}^i for arbitrary k in a similar way. Again one starts by writing $iPkP$ as a disjoint union of sets of the form $iBwP$. Next by induction on $l(w)$ this is rewritten as a disjoint union of cosets uvP , where $u \in U_v^-$ and $v \in L_J$. As an algorithm this works perfectly well, but it is not so easy to give a simple closed expression for p_{jk}^i .

5. Computation in the Weyl group

We shall briefly discuss the way in which several items in the Weyl group have been computed.

- (i) The length function l .

The only essential ingredient in our computations is the length function; all other computations could be done by general group theoretic routines. But given the permutation representation of the fundamental reflections on the root system Φ and a product representation $w = s_1 \cdot s_2 \cdots s_m$ (not necessarily minimal), we find $l(w)$ from

$$l(w) = |\{\alpha \in \Phi : \alpha > 0 \text{ and } w\alpha < 0\}|$$

(see e.g. Bourbaki [1] Chap. VI, §1.6 Cor. 2).

- (ii) Canonical representatives of the cosets wW_J .

Let Φ be the coroot perpendicular to all fundamental roots except the one corresponding to r . Then Φ has stabilizer W_J in W , and the images of ϕ under W are in 1-1 correspondence with the cosets wW_J .

- (iii) Equality in W .

Similarly, let ρ be the sum of all positive roots. Then $w\rho = w'\rho$ iff $w = w'$.

- (iv) Double coset representatives.

Given a suitable lexicographic and recursive way of generating the cosets wW_J , the first of these to belong to a certain coset $W_J wW_J$ will have $w \in D_J$. All cosets in the same double coset are found by premultiplying previously found cosets with reflections in J . However, the set D_J of distinguished double coset representatives can be found without listing all single cosets wW_J : given $w \in D_J$, one can determine all elements from $D_J \cap wL$, where $L = L_J \cap W_J r$, by simply sieving all right and left J -reduced words from wL (compare with (i)). In view of the fact that W is generated by $J \cup \{r\}$, iteration of this process will eventually yield all of D_J (one can start with $w = 1$). We have done so for the Weyl groups of type F_4, E_6, E_7, E_8 . The cardinalities of D_J , i.e. the permutation ranks, have been given above.

References

- [1] N. Bourbaki, *Groupes et Algèbres de Lie*, Chap. 4,5 et 6, Hermann, Paris, 1968.
- [2] A.E. Brouwer and A.M. Cohen, "Some remarks on Tits geometries" (with an appendix by J. Tits), *Indagationes Mathematica*, 45 (1983) 392-402.
- [3] A.E. Brouwer and A.M. Cohen, "Local recognition of Tits geometries of classical type", preprint.

- [4] R.W. Carter, *Simple groups of Lie type*, Wiley, London, 1972.
- [5] A.M. Cohen, "Semisimple Lie groups from a geometric viewpoint", in: *The Structure of Real Semisimple Lie Groups* (T.H. Koornwinder, editor) MC Syllabus 49, Math. Centre, Amsterdam, 1982, pp. 41-77.
- [6] A.M. Cohen, "Points and lines in metasymplectic spaces", *Annals of Discrete Mathematics* 18 (1983) 193-196.
- [7] L. Solomon, "A Mackey formula in the group ring of a Coxeter group", *Journal of Algebra* 41 (1976) 255-268.
- [8] J. Tits, "Les "formes réelles" des groupes de type E_6 ", Séminaire Bourbaki, no. 162, 1958, Paris.
- [9] J. Tits, *Buildings of Spherical Type and Finite BN-Pairs*, Lecture Notes in Mathematics 386, Springer, Berlin, 1974.
- [10] J. Tits, "A local approach to buildings", in: *The Geometric Vein* (C. Davis et al., editors) Springer, Berlin, 1982, pp. 519-547.

Appendix

$E_{6,1}$

27 cosets

3 double cosets

Sizes:

0: ()

[1] 1

1: (1)

[16] $q + q^2 + q^3 + 2q^4 + 2q^5 + 2q^6 + 2q^7 + 2q^8 + q^9 + q^{10} + q^{11}$

2: (12364321)

[10] $q^8 + q^9 + q^{10} + q^{11} + 2q^{12} + q^{13} + q^{14} + q^{15} + q^{16}$

Neighbours of a point in 0:

1: [16] $q + q^2 + q^3 + 2q^4 + 2q^5 + 2q^6 + 2q^7 + 2q^8 + q^9 + q^{10} + q^{11}$

Neighbours of a point in 1:

0: [1] 1

1: [10] $-1 + q + q^2 + q^3 + 2q^4 + 2q^5 + 2q^6 + q^7 + q^8$

2: [5] $q^7 + q^8 + q^9 + q^{10} + q^{11}$

Neighbours of a point in 2:

$$\begin{aligned} 1: [8] & \quad 1 + q + q^2 + 2q^3 + q^4 + q^5 + q^6 \\ 2: [8] & \quad -1 - q^3 + q^4 + q^5 + q^6 + 2q^7 + 2q^8 + q^9 + q^{10} + q^{11} \end{aligned}$$

E_{6,2}

216 cosets

10 double cosets

Sizes:

0: ()

$$[1] \quad 1$$

1: (2)

$$[20] \quad q + 2q^2 + 3q^3 + 4q^4 + 4q^5 + 3q^6 + 2q^7 + q^8$$

2: (2312)

$$[30] \quad q^4 + 2q^5 + 4q^6 + 5q^7 + 6q^8 + 5q^9 + 4q^{10} + 2q^{11} + q^{12}$$

3: (236432)

$$[10] \quad q^6 + 2q^7 + 2q^8 + 2q^9 + 2q^{10} + q^{11}$$

4: (2364312)

$$[60] \quad q^7 + 3q^8 + 6q^9 + 9q^{10} + 11q^{11} + 11q^{12} + 9q^{13} + 6q^{14} + 3q^{15} + q^{16}$$

5: (23645342312)

$$[20] \quad q^{11} + 2q^{12} + 3q^{13} + 4q^{14} + 4q^{15} + 3q^{16} + 2q^{17} + q^{18}$$

6: (23412365432)

$$[20] \quad q^{11} + 2q^{12} + 3q^{13} + 4q^{14} + 4q^{15} + 3q^{16} + 2q^{17} + q^{18}$$

7: (2341236342312)

$$[5] \quad q^{13} + q^{14} + q^{15} + q^{16} + q^{17}$$

8: (23412365342312)

$$[40] \quad q^{14} + 3q^{15} + 5q^{16} + 7q^{17} + 8q^{18} + 7q^{19} + 5q^{20} + 3q^{21} + q^{22}$$

9: (2364534123645342312)

$$[10] \quad q^{24} + q^{25}$$

Neighbours of a point in 0:

$$1: [20] \quad 3q^6 + 2q^7 + q^8$$

Neighbours of a point in 1:

$$0: [1] \quad 1$$

$$1: [7] \quad -1 + q + 2q^2 + 2q^3 + 2q^4 + q^5$$

$$2: [6] \quad q^3 + 2q^4 + 2q^5 + q^6$$

$$3: [3] \quad q^5 + q^6 + q^7$$

$$4: [3] \quad q^6 + q^7 + q^8$$

Neighbours of a point in 2:

- 1: [4] $1 + 2q + q^2$
- 2: [6] $-1 - q + q^2 + 3q^3 + 3q^4 + q^5$
- 4: [8] $q^4 + 3q^5 + 3q^6 + q^7$
- 5: [2] $q^7 + q^8$

Neighbours of a point in 3:

- 1: [6] $1 + q + 2q^2 + q^3 + q^4$
- 3: [4] $-1 - q^2 + q^3 + q^4 + 2q^5 + q^6 + q^7$
- 4: [6] $q^2 + q^3 + 2q^4 + q^5 + q^6$
- 6: [4] $q^5 + q^6 + q^7 + q^8$

Neighbours of a point in 4:

- 1: [1] 1
- 2: [4] $q + 2q^2 + q^3$
- 3: [1] q
- 4: [7] $-1 - q + 2q^3 + 4q^4 + 3q^5$
- 5: [2] $q^6 + q^7$
- 6: [2] $q^5 + q^6$
- 7: [1] q^6
- 8: [2] $q^7 + q^8$

Neighbours of a point in 5:

- 2: [3] $1 + q + q^2$
- 4: [6] $q^2 + 2q^3 + 2q^4 + q^5$
- 5: [4] $-1 + q^3 + q^4 + q^5 + q^6 + q^7$
- 8: [6] $q^4 + 2q^5 + 2q^6 + q^7$
- 9: [1] q^8

Neighbours of a point in 6:

- 3: [2] $1 + q$
- 4: [6] $q + 2q^2 + 2q^3 + q^4$
- 6: [6] $-1 - q + q^3 + 3q^4 + 3q^5 + q^6$
- 8: [6] $q^5 + 2q^6 + 2q^7 + q^8$

Neighbours of a point in 7:

- 4: [12] $1 + 2q + 3q^2 + 3q^3 + 2q^4 + q^5$
- 7: [0] $-1 - q - q^2 + q^4 + q^5 + q^6$
- 8: [8] $q^4 + 2q^5 + 2q^6 + 2q^7 + q^8$

Neighbours of a point in 8:

- 4: [3] $1 + q + q^2$
 5: [3] $q + q^2 + q^3$
 6: [3] $q^2 + q^3 + q^4$
 7: [1] q^3
 8: [7] $-1 - q - q^2 + 3q^4 + 4q^5 + 2q^6 + q^7$
 9: [3] $q^6 + q^7 + q^8$

Neighbours of a point in 9:

- 5: [2] $1 + q$
 8: [12] $q + 3q^2 + 4q^3 + 3q^4 + q^5$
 9: [6] $-1 - q - q^2 - q^3 + q^4 + 3q^5 + 3q^6 + 2q^7 + q^8$

$E_{6,6}$

72 cosets

5 double cosets

Sizes:

0: ()

[1] 1

1: (6)

[20] $q + q^2 + 2q^3 + 3q^4 + 3q^5 + 3q^6 + 3q^7 + 2q^8 + q^9 + q^{10}$

2: (634236)

[30] $q^6 + 2q^7 + 3q^8 + 4q^9 + 5q^{10} + 5q^{11} + 4q^{12} + 3q^{13} + 2q^{14} + q^{15}$

3: (63452341236)

[20] $q^{11} + q^{12} + 2q^{13} + 3q^{14} + 3q^{15} + 3q^{16} + 3q^{17} + 2q^{18} + q^{19} + q^{20}$

4: (634523412363452341236)

[1] q^{21}

Neighbours of a point in 0:

1: [20] $q + q^2 + 2q^3 + 3q^4 + 3q^5 + 3q^6 + 3q^7 + 2q^8 + q^9 + q^{10}$

Neighbours of a point in 1:

- 0: [1] 1
 1: [9] $-1 + q + q^2 + 2q^3 + 3q^4 + 2q^5 + q^6$
 2: [9] $q^5 + 2q^6 + 3q^7 + 2q^8 + q^9$
 3: [1] q^{10}

Neighbours of a point in 2:

- 1: [6] $1 + q + 2q^2 + q^3 + q^4$
 2: [8] $-1 - q^2 + q^3 + 2q^4 + 3q^5 + 2q^6 + 2q^7$

$$3: [6] \quad q^6 + q^7 + 2q^8 + q^9 + q^{10}$$

Neighbours of a point in 3:

$$1: [1] \quad 1$$

$$2: [9] \quad q + 2q^2 + 3q^3 + 2q^4 + q^5$$

$$3: [9] \quad -1 - q^2 - q^3 + q^4 + 2q^5 + 3q^6 + 3q^7 + 2q^8 + q^9$$

$$4: [1] \quad q^{10}$$

Neighbours of a point in 4:

$$3: [20] \quad 1 + q + 2q^2 + 3q^3 + 3q^4 + 3q^5 + 3q^6 + 2q^7 + q^8 + q^9$$

$$4: [0] \quad -1 - q^2 - q^3 + q^7 + q^8 + q^{10}$$

$E_{7,1}$

56 cosets

4 double cosets

Sizes:

0: ()

$$[1] \quad 1$$

1: (1)

$$[27] \quad q + q^2 + q^3 + q^4 + 2q^5 + 2q^6 + 2q^7 + 2q^8 + 3q^9 + 2q^{10} + 2q^{11} + 2q^{12} + 2q^{13} + q^{14} + q^{15} + q^{16} + q^{17}$$

2: (1234754321)

$$[27] \quad q^{10} + q^{11} + q^{12} + q^{13} + 2q^{14} + 2q^{15} + 2q^{16} + 2q^{17} + 3q^{18} + 2q^{19} + 2q^{20} + 2q^{21} + 2q^{22} + q^{23} + q^{24} + q^{25} + q^{26}$$

3: (123475645347234512347654321)

$$[1] \quad q^{27}$$

Neighbours of a point in 0:

$$1: [27] \quad q + q^2 + q^3 + q^4 + 2q^5 + 2q^6 + 2q^7 + 2q^8 + 3q^9 + 2q^{10} + 2q^{11} + 2q^{12} + 2q^{13} + q^{14} + q^{15} + q^{16} + q^{17}$$

Neighbours of a point in 1:

$$0: [1] \quad 1$$

$$1: [16] \quad -1 + q + q^2 + q^3 + q^4 + 2q^5 + 2q^6 + 2q^7 + 2q^8 + 2q^9 + q^{10} + q^{11} + q^{12}$$

$$2: [10] \quad q^9 + q^{10} + q^{11} + q^{12} + 2q^{13} + q^{14} + q^{15} + q^{16} + q^{17}$$

Neighbours of a point in 2:

$$1: [10] \quad 1 + q + q^2 + q^3 + 2q^4 + q^5 + q^6 + q^7 + q^8$$

$$2: [16] \quad -1 - q^4 + q^5 + q^6 + q^7 + q^8 + 3q^9 + 2q^{10} + 2q^{11} + 2q^{12} + 2q^{13} + q^{14} + q^{15} + q^{16}$$

$$3: [1] \quad q^{17}$$

Neighbours of a point in 3:

$$2: [27] \quad 1 + q + q^2 + q^3 + 2q^4 + 2q^5 + 2q^6 + 2q^7 + 3q^8 + 2q^9 + 2q^{10} + 2q^{11} + 2q^{12} + q^{13} + q^{14} + q^{15} + q^{16}$$

$$3: [0] \quad -1 - q^4 - q^8 + q^9 + q^{13} + q^{17}$$

$E_{7,6}$

126 cosets

5 double cosets

Sizes:

0: ()

$$[1] \quad 1$$

1: (6)

$$[32] \quad q + q^2 + q^3 + 2q^4 + 2q^5 + 3q^6 + 3q^7 + 3q^8 + 3q^9 + 3q^{10} + 3q^{11} + 2q^{12} + 2q^{13} + q^{14} + q^{15} + q^{16}$$

2: (65473456)

$$[60] \quad q^8 + q^9 + 2q^{10} + 2q^{11} + 4q^{12} + 4q^{13} + 5q^{14} + 5q^{15} + 6q^{16} + 6q^{17} + 5q^{18} + 5q^{19} + 4q^{20} + 4q^{21} + 2q^{22} + 2q^{23} + q^{24} + q^{25}$$

3: (65473452347123456)

$$[32] \quad q^{17} + q^{18} + q^{19} + 2q^{20} + 2q^{21} + 3q^{22} + 3q^{23} + 3q^{24} + 3q^{25} + 3q^{26} + 3q^{27} + 2q^{28} + 2q^{29} + q^{30} + q^{31} + q^{32}$$

4: (654734562345123474563452347123456)

$$[1] \quad q^{33}$$

Neighbours of a point in 0:

$$1: [32] \quad q + q^2 + q^3 + 2q^4 + 2q^5 + 3q^6 + 3q^7 + 3q^8 + 3q^9 + 3q^{10} + 3q^{11} + 2q^{12} + 2q^{13} + q^{14} + q^{15} + q^{16}$$

Neighbours of a point in 1:

$$0: [1] \quad 1$$

$$1: [15] \quad -1 + q + q^2 + q^3 + 2q^4 + 2q^5 + 3q^6 + 2q^7 + 2q^8 + q^9 + q^{10}$$

$$2: [15] \quad q^7 + q^8 + 2q^9 + 2q^{10} + 3q^{11} + 2q^{12} + 2q^{13} + q^{14} + q^{15}$$

$$3: [1] \quad q^{16}$$

Neighbours of a point in 2:

$$1: [8] \quad 1 + q + q^2 + 2q^3 + q^4 + q^5 + q^6$$

$$2: [16] \quad -1 - q^3 + q^4 + q^5 + 2q^6 + 3q^7 + 3q^8 + 3q^9 + 2q^{10} + 2q^{11} + q^{12}$$

$$3: [8] \quad q^{10} + q^{11} + q^{12} + 2q^{13} + q^{14} + q^{15} + q^{16}$$

Neighbours of a point in 3:

- 1: [1] 1
 2: [15] $q + q^2 + 2q^3 + 2q^4 + 3q^5 + 2q^6 + 2q^7 + q^8 + q^9$
 3: [15] $-1 - q^3 - q^5 + q^6 + q^7 + 2q^8 + 2q^9 + 3q^{10} + 3q^{11} + 2q^{12} + 2q^{13} + q^{14} + q^{15}$
 4: [1] q^{16}

Neighbours of a point in 4:

- 3: [32] $1 + q + q^2 + 2q^3 + 2q^4 + 3q^5 + 3q^6 + 3q^7 + 3q^8 + 3q^9 + 3q^{10} + 2q^{11} + 2q^{12} + q^{13} + q^{14} + q^{15}$
 4: [0] $-1 - q^3 - q^5 + q^{11} + q^{13} + q^{16}$

$E_{7,7}$

576 cosets

10 double cosets

Sizes:

0: ()

[1] 1

1: (7)

[35] $q + q^2 + 2q^3 + 3q^4 + 4q^5 + 4q^6 + 5q^7 + 4q^8 + 4q^9 + 3q^{10} + 2q^{11} + q^{12} + q^{13}$

2: (745347)

[105] $q^6 + 2q^7 + 4q^8 + 6q^9 + 9q^{10} + 11q^{11} + 13q^{12} + 13q^{13} + 13q^{14} + 11q^{15} + 9q^{16} + 6q^{17} + 4q^{18} + 2q^{19} + q^{20}$

3: (74563452347)

[140] $q^{11} + 2q^{12} + 4q^{13} + 7q^{14} + 10q^{15} + 13q^{16} + 16q^{17} + 17q^{18} + 17q^{19} + 16q^{20} + 13q^{21} + 10q^{22} + 7q^{23} + 4q^{24} + 2q^{25} + q^{26}$

4: (745347234512347)

[7] $q^{15} + q^{16} + q^{17} + q^{18} + q^{19} + q^{20} + q^{21}$

5: (7453476234512347)

[140] $q^{16} + 2q^{17} + 4q^{18} + 7q^{19} + 10q^{20} + 13q^{21} + 16q^{22} + 17q^{23} + 17q^{24} + 16q^{25} + 13q^{26} + 10q^{27} + 7q^{28} + 4q^{29} + 2q^{30} + q^{31}$

6: (745634523474563452347)

[7] $q^{21} + q^{22} + q^{23} + q^{24} + q^{25} + q^{26} + q^{27}$

7: (7456345234745634512347)

[105] $q^{22} + 2q^{23} + 4q^{24} + 6q^{25} + 9q^{26} + 11q^{27} + 13q^{28} + 13q^{29} + 13q^{30} + 11q^{31} + 9q^{32} + 6q^{33} + 4q^{34} + 2q^{35} + q^{36}$

8: (74534762345123473456234512347)

$$[35] \quad q^{29} + q^{30} + 2q^{31} + 3q^{32} + 4q^{33} + 4q^{34} + 5q^{35} + 4q^{36} + 4q^{37} + 3q^{38} + 2q^{39} + q^{40} + q^{41}$$

9: (745347623451234734562345123473456234512347)

$$[1] \quad q^{42}$$

Neighbours of a point in 0:

$$1: [35] \quad q + q^2 + 2q^3 + 3q^4 + 4q^5 + 4q^6 + 5q^7 + 4q^8 + 4q^9 + 3q^{10} + 2q^{11} + q^{12} + q^{13}$$

Neighbours of a point in 1:

$$0: [1] \quad 1$$

$$1: [12] \quad -1 + q + q^2 + 2q^3 + 3q^4 + 3q^5 + 2q^6 + q^7$$

$$2: [18] \quad q^5 + 2q^6 + 4q^7 + 4q^8 + 4q^9 + 2q^{10} + q^{11}$$

$$3: [4] \quad q^{10} + q^{11} + q^{12} + q^{13}$$

Neighbours of a point in 2:

$$1: [6] \quad 1 + q + 2q^2 + q^3 + q^4$$

$$2: [12] \quad -1 - q^2 + q^3 + 2q^4 + 4q^5 + 3q^6 + 3q^7 + q^8$$

$$3: [12] \quad q^6 + 2q^7 + 3q^8 + 3q^9 + 2q^{10} + q^{11}$$

$$4: [1] \quad q^9$$

$$5: [4] \quad q^{10} + q^{11} + q^{12} + q^{13}$$

Neighbours of a point in 3:

$$1: [1] \quad 1$$

$$2: [9] \quad q + 2q^2 + 3q^3 + 2q^4 + q^5$$

$$3: [12] \quad -1 - q^2 - q^3 + q^4 + 3q^5 + 4q^6 + 4q^7 + 2q^8 + q^9$$

$$5: [9] \quad q^7 + 2q^8 + 3q^9 + 2q^{10} + q^{11}$$

$$6: [1] \quad q^{10}$$

$$7: [3] \quad q^{11} + q^{12} + q^{13}$$

Neighbours of a point in 4:

$$2: [15] \quad 1 + q + 2q^2 + 2q^3 + 3q^4 + 2q^5 + 2q^6 + q^7 + q^8$$

$$4: [0] \quad -1 - q^2 - q^4 + q^5 + q^7 + q^9$$

$$5: [20] \quad q^4 + q^5 + 2q^6 + 3q^7 + 3q^8 + 3q^9 + 3q^{10} + 2q^{11} + q^{12} + q^{13}$$

Neighbours of a point in 5:

$$2: [3] \quad 1 + q + q^2$$

$$3: [9] \quad q^2 + 2q^3 + 3q^4 + 2q^5 + q^6$$

$$4: [1] \quad q^3$$

$$5: [12] \quad -1 - q^2 - q^3 + 2q^5 + 3q^6 + 5q^7 + 3q^8 + 2q^9$$

$$7: [9] \quad q^8 + 2q^9 + 3q^{10} + 2q^{11} + q^{12}$$

$$8: [1] \quad q^{13}$$

Neighbours of a point in 6:

$$3: [20] \quad 1 + q + 2q^2 + 3q^3 + 3q^4 + 3q^5 + 3q^6 + 2q^7 + q^8 + q^9$$

$$6: [0] \quad -1 - q^2 - q^3 + q^7 + q^8 + q^{10}$$

$$7: [15] \quad q^5 + q^6 + 2q^7 + 2q^8 + 3q^9 + 2q^{10} + 2q^{11} + q^{12} + q^{13}$$

Neighbours of a point in 7:

$$3: [4] \quad 1 + q + q^2 + q^3$$

$$5: [12] \quad q^2 + 2q^3 + 3q^4 + 3q^5 + 2q^6 + q^7$$

$$6: [1] \quad q^4$$

$$7: [12] \quad -1 - q^2 - q^3 - q^4 + q^5 + 2q^6 + 4q^7 + 4q^8 + 3q^9 + 2q^{10}$$

$$8: [6] \quad q^9 + q^{10} + 2q^{11} + q^{12} + q^{13}$$

Neighbours of a point in 8:

$$5: [4] \quad 1 + q + q^2 + q^3$$

$$7: [18] \quad q^2 + 2q^3 + 4q^4 + 4q^5 + 4q^6 + 2q^7 + q^8$$

$$8: [12] \quad -1 - q^2 - q^3 - q^4 + 3q^7 + 3q^8 + 4q^9 + 3q^{10} + 2q^{11} + q^{12}$$

$$9: [1] \quad q^{13}$$

Neighbours of a point in 9:

$$8: [35] \quad 1 + q + 2q^2 + 3q^3 + 4q^4 + 4q^5 + 5q^6 + 4q^7 + 4q^8 + 3q^9 + 2q^{10} + q^{11} + q^{12}$$

$$9: [0] \quad -1 - q^2 - q^3 - q^4 - q^6 + q^7 + q^9 + q^{10} + q^{11} + q^{13}$$

$E_{8,1}$

240 cosets

5 double cosets

Sizes:

0: ()

$$[1] \quad 1$$

1: (1)

$$[56] \quad q + q^2 + q^3 + q^4 + q^5 + 2q^6 + 2q^7 + 2q^8 + 2q^9 + 3q^{10} + 3q^{11} + 3q^{12} + 3q^{13} + 3q^{14} + 3q^{15} + 3q^{16} + 3q^{17} + 3q^{18} + 3q^{19} + 2q^{20} + 2q^{21} + 2q^{22} + 2q^{23} + q^{24} + q^{25} + q^{26} + q^{27} + q^{28}$$

2: (123458654321)

$$[126] \quad q^{12} + q^{13} + q^{14} + q^{15} + 2q^{16} + 2q^{17} + 3q^{18} + 3q^{19} + 4q^{20} + 4q^{21} + 5q^{22} + 5q^{23} + 6q^{24} + 6q^{25} + 6q^{26} + 6q^{27} + 7q^{28} + 7q^{29} + 6q^{30} + 6q^{31} + 6q^{32} + 6q^{33} + 5q^{34} + 5q^{35} + 4q^{36} + 4q^{37} + 3q^{38} + 3q^{39} + 2q^{40} + 2q^{41} + q^{42} + q^{43} + q^{44} + q^{45}$$

3: (12345867564583456234587654321)

$$[56] \quad q^{29} + q^{30} + q^{31} + q^{32} + q^{33} + 2q^{34} + 2q^{35} + 2q^{36} + 2q^{37} + 3q^{38} + 3q^{39} + 3q^{40} + 3q^{41} + 3q^{42} + 3q^{43} + 3q^{44} + 3q^{45} + 3q^{46} + 3q^{47} + 2q^{48} + 2q^{49} + 2q^{50} + 2q^{51} + q^{52} + q^{53} + q^{54} + q^{55} + q^{56}$$

4: (123458675645834567234561234585674563458234561234587654321)

$$[1] \quad q^{57}$$

Neighbours of a point in 0:

$$1: [56] \quad q + q^2 + q^3 + q^4 + q^5 + 2q^6 + 2q^7 + 2q^8 + 2q^9 + 3q^{10} + 3q^{11} + 3q^{12} + 3q^{13} + 3q^{14} + 3q^{15} + 3q^{16} + 3q^{17} + 3q^{18} + 3q^{19} + 2q^{20} + 2q^{21} + 2q^{22} + 2q^{23} + q^{24} + q^{25} + q^{26} + q^{27} + q^{28}$$

Neighbours of a point in 1:

$$0: [1] \quad 1$$

$$1: [27] \quad -1 + q + q^2 + q^3 + q^4 + q^5 + 2q^6 + 2q^7 + 2q^8 + 2q^9 + 3q^{10} + 2q^{11} + 2q^{12} + 2q^{13} + 2q^{14} + q^{15} + q^{16} + q^{17} + q^{18}$$

$$2: [27] \quad q^{11} + q^{12} + q^{13} + q^{14} + 2q^{15} + 2q^{16} + 2q^{17} + 2q^{18} + 3q^{19} + 2q^{20} + 2q^{21} + 2q^{22} + 2q^{23} + q^{24} + q^{25} + q^{26} + q^{27}$$

$$3: [1] \quad q^{28}$$

Neighbours of a point in 2:

$$1: [12] \quad 1 + q + q^2 + q^3 + q^4 + 2q^5 + q^6 + q^7 + q^8 + q^9 + q^{10}$$

$$2: [32] \quad -1 - q^5 + q^6 + q^7 + q^8 + q^9 + 2q^{10} + 3q^{11} + 3q^{12} + 3q^{13} + 3q^{14} + 3q^{15} + 3q^{16} + 3q^{17} + 2q^{18} + 2q^{19} + q^{20} + q^{21} + q^{22}$$

$$3: [12] \quad q^{18} + q^{19} + q^{20} + q^{21} + q^{22} + 2q^{23} + q^{24} + q^{25} + q^{26} + q^{27} + q^{28}$$

Neighbours of a point in 3:

$$1: [1] \quad 1$$

$$2: [27] \quad q + q^2 + q^3 + q^4 + 2q^5 + 2q^6 + 2q^7 + 2q^8 + 3q^9 + 2q^{10} + 2q^{11} + 2q^{12} + 2q^{13} + q^{14} + q^{15} + q^{16} + q^{17}$$

$$3: [27] \quad -1 - q^5 - q^9 + q^{10} + q^{11} + q^{12} + q^{13} + 2q^{14} + 2q^{15} + 2q^{16} + 2q^{17} + 3q^{18} + 3q^{19} + 2q^{20} + 2q^{21} + 2q^{22} + 2q^{23} + q^{24} + q^{25} + q^{26} + q^{27}$$

$$4: [1] \quad q^{28}$$

Neighbours of a point in 4:

$$3: [56] \quad 1 + q + q^2 + q^3 + q^4 + 2q^5 + 2q^6 + 2q^7 + 2q^8 + 3q^9 + 3q^{10} + 3q^{11} + 3q^{12} + 3q^{13} + 3q^{14} + 3q^{15} + 3q^{16} + 3q^{17} + 3q^{18} + 2q^{19} + 2q^{20} + 2q^{21} + 2q^{22} + q^{23} + q^{24} + q^{25} + q^{26} + q^{27}$$

$$4: [0] \quad -1 - q^5 - q^9 + q^{19} + q^{23} + q^{28}$$

E_{8,7}

2160 cosets

10 double cosets

Sizes:

0: ()

$$[1] \quad 1$$

1: (7)

$$[64] \quad q + q^2 + q^3 + 2q^4 + 2q^5 + 3q^6 + 4q^7 + 4q^8 + 4q^9 + 5q^{10} + 5q^{11} + 5q^{12} + 5q^{13} + 4q^{14} + 4q^{15} + 4q^{16} + 3q^{17} + 2q^{18} + 2q^{19} + q^{20} + q^{21} + q^{22}$$

2: (76584567)

$$[280] \quad q^8 + q^9 + 2q^{10} + 3q^{11} + 5q^{12} + 6q^{13} + 9q^{14} + 10q^{15} + 13q^{16} + 15q^{17} + 17q^{18} + 18q^{19} + 20q^{20} + 20q^{21} + 20q^{22} + 20q^{23} + 18q^{24} + 17q^{25} + 15q^{26} + 13q^{27} + 10q^{28} + 9q^{29} + 6q^{30} + 5q^{31} + 3q^{32} + 2q^{33} + q^{34} + q^{35}$$

3: (76584563458234567)

$$[448] \quad q^{17} + 2q^{18} + 3q^{19} + 5q^{20} + 7q^{21} + 10q^{22} + 14q^{23} + 17q^{24} + 20q^{25} + 24q^{26} + 27q^{27} + 30q^{28} + 32q^{29} + 32q^{30} + 32q^{31} + 32q^{32} + 30q^{33} + 27q^{34} + 24q^{35} + 20q^{36} + 17q^{37} + 14q^{38} + 10q^{39} + 7q^{40} + 5q^{41} + 3q^{42} + 2q^{43} + q^{44}$$

4: (765845673456234581234567)

$$[560] \quad q^{24} + q^{25} + 2q^{26} + 4q^{27} + 6q^{28} + 8q^{29} + 12q^{30} + 15q^{31} + 19q^{32} + 24q^{33} + 27q^{34} + 31q^{35} + 35q^{36} + 37q^{37} + 38q^{38} + 40q^{39} + 38q^{40} + 37q^{41} + 35q^{42} + 31q^{43} + 27q^{44} + 24q^{45} + 19q^{46} + 15q^{47} + 12q^{48} + 8q^{49} + 6q^{50} + 4q^{51} + 2q^{52} + q^{53} + q^{54}$$

5: (765845673456234585674563458234567)

$$[14] \quad q^{33} + q^{34} + q^{35} + q^{36} + q^{37} + q^{38} + 2q^{39} + q^{40} + q^{41} + q^{42} + q^{43} + q^{44} + q^{45}$$

6: (7658456734562345856745634581234567)

$$[448] \quad q^{34} + 2q^{35} + 3q^{36} + 5q^{37} + 7q^{38} + 10q^{39} + 14q^{40} + 17q^{41} + 20q^{42} + 24q^{43} + 27q^{44} + 30q^{45} + 32q^{46} + 32q^{47} + 32q^{48} + 32q^{49} + 30q^{50} + 27q^{51} + 24q^{52} + 20q^{53} + 17q^{54} + 14q^{55} + 10q^{56} + 7q^{57} + 5q^{58} + 3q^{59} + 2q^{60} + q^{61}$$

7: (7658456345872345612345845673456234581234567)

$$[280] \quad q^{43} + q^{44} + 2q^{45} + 3q^{46} + 5q^{47} + 6q^{48} + 9q^{49} + 10q^{50} + 13q^{51} + 15q^{52} + 17q^{53} + 18q^{54} + 20q^{55} + 20q^{56} + 20q^{57} + 20q^{58} + 18q^{59} + 17q^{60} + 15q^{61} + 13q^{62} + 10q^{63} + 9q^{64} + 6q^{65} + 5q^{66} + 3q^{67} + 2q^{68} + q^{69} + q^{70}$$

8: (76584563458723456123458456734562345845673456234581234567)

$$[64] \quad q^{56} + q^{57} + q^{58} + 2q^{59} + 2q^{60} + 3q^{61} + 4q^{62} + 4q^{63} + 4q^{64} + 5q^{65} + 5q^{66} + 5q^{67} + 5q^{68} + 4q^{69} + 4q^{70} + 4q^{71} + 3q^{72} + 2q^{73} + 2q^{74} + q^{75} + q^{76} + q^{77}$$

9: (765845673456234585674561234586723456123458345672345612345845673456234581234567)

$$[1] \quad q^{78}$$

Neighbours of a point in 0:

$$1: [64] \quad q + q^2 + q^3 + 2q^4 + 2q^5 + 3q^6 + 4q^7 + 4q^8 + 4q^9 + 5q^{10} + 5q^{11} + 5q^{12} + 5q^{13} + 4q^{14} + 4q^{15} + 4q^{16} + 3q^{17} + 2q^{18} + 2q^{19} + q^{20} + q^{21} + q^{22}$$

Neighbours of a point in 1:

$$0: [1] \quad 1$$

$$1: [21] \quad -1 + q + q^2 + q^3 + 2q^4 + 2q^5 + 3q^6 + 3q^7 + 3q^8 + 2q^9 + 2q^{10} + q^{11} + q^{12}$$

$$2: [35] \quad q^7 + q^8 + 2q^9 + 3q^{10} + 4q^{11} + 4q^{12} + 5q^{13} + 4q^{14} + 4q^{15} + 3q^{16} + 2q^{17} + q^{18} + q^{19}$$

$$3: [7] \quad q^{16} + q^{17} + q^{18} + q^{19} + q^{20} + q^{21} + q^{22}$$

Neighbours of a point in 2:

$$1: [8] \quad 1 + q + q^2 + 2q^3 + q^4 + q^5 + q^6$$

$$2: [24] \quad -1 - q^3 + q^4 + q^5 + 2q^6 + 4q^7 + 4q^8 + 4q^9 + 4q^{10} + 3q^{11} + 2q^{12} + q^{13}$$

$$3: [24] \quad q^{10} + 2q^{11} + 3q^{12} + 4q^{13} + 4q^{14} + 4q^{15} + 3q^{16} + 2q^{17} + q^{18}$$

$$4: [8] \quad q^{16} + q^{17} + q^{18} + 2q^{19} + q^{20} + q^{21} + q^{22}$$

Neighbours of a point in 3:

$$1: [1] \quad 1$$

$$2: [15] \quad q + q^2 + 2q^3 + 2q^4 + 3q^5 + 2q^6 + 2q^7 + q^8 + q^9$$

$$3: [21] \quad -1 - q^3 - q^5 + q^6 + 2q^7 + 3q^8 + 3q^9 + 4q^{10} + 4q^{11} + 3q^{12} + 2q^{13} + q^{14} + q^{15}$$

$$4: [20] \quad q^{10} + q^{11} + 2q^{12} + 3q^{13} + 3q^{14} + 3q^{15} + 3q^{16} + 2q^{17} + q^{18} + q^{19}$$

$$5: [1] \quad q^{16}$$

$$6: [6] \quad q^{17} + q^{18} + q^{19} + q^{20} + q^{21} + q^{22}$$

Neighbours of a point in 4:

$$2: [4] \quad 1 + q + q^2 + q^3$$

$$3: [16] \quad q^3 + 2q^4 + 3q^5 + 4q^6 + 3q^7 + 2q^8 + q^9$$

$$4: [24] \quad -1 - q^3 - q^5 - q^6 + q^7 + 2q^8 + 3q^9 + 5q^{10} + 5q^{11} + 5q^{12} + 4q^{13} + 2q^{14} + q^{15}$$

$$6: [16] \quad q^{13} + 2q^{14} + 3q^{15} + 4q^{16} + 3q^{17} + 2q^{18} + q^{19}$$

$$7: [4] \quad q^{19} + q^{20} + q^{21} + q^{22}$$

Neighbours of a point in 5:

$$3: [32] \quad 1 + q + q^2 + 2q^3 + 2q^4 + 3q^5 + 3q^6 + 3q^7 + 3q^8 + 3q^9 + 3q^{10} + 2q^{11} + 2q^{12} + q^{13} + q^{14} + q^{15}$$

$$5: [0] \quad -1 - q^3 - q^5 + q^{11} + q^{13} + q^{16}$$

$$6: [32] \quad q^7 + q^8 + q^9 + 2q^{10} + 2q^{11} + 3q^{12} + 3q^{13} + 3q^{14} + 3q^{15} + 3q^{16} + 3q^{17} + 2q^{18} + 2q^{19} + q^{20} + q^{21} + q^{22}$$

Neighbours of a point in 6:

$$3: [6] \quad 1 + q + q^2 + q^3 + q^4 + q^5$$

$$4: [20] \quad q^3 + q^4 + 2q^5 + 3q^6 + 3q^7 + 3q^8 + 3q^9 + 2q^{10} + q^{11} + q^{12}$$

$$5: [1] \quad q^6$$

$$6: [21] \quad -1 - q^3 - q^5 - q^6 + q^7 + q^8 + q^9 + 3q^{10} + 4q^{11} + 4q^{12} + 4q^{13} + 3q^{14} + 2q^{15} + 2q^{16}$$

$$7: [15] \quad q^{13} + q^{14} + 2q^{15} + 2q^{16} + 3q^{17} + 2q^{18} + 2q^{19} + q^{20} + q^{21}$$

$$8: [1] \quad q^{22}$$

Neighbours of a point in 7:

$$4: [8] \quad 1 + q + q^2 + 2q^3 + q^4 + q^5 + q^6$$

$$6: [24] \quad q^4 + 2q^5 + 3q^6 + 4q^7 + 4q^8 + 4q^9 + 3q^{10} + 2q^{11} + q^{12}$$

$$7: [24] \quad -1 - q^3 - q^5 - q^6 + 2q^{10} + 3q^{11} + 4q^{12} + 5q^{13} + 4q^{14} + 4q^{15} + 3q^{16} + 2q^{17} + q^{18}$$

$$8: [8] \quad q^{16} + q^{17} + q^{18} + 2q^{19} + q^{20} + q^{21} + q^{22}$$

Neighbours of a point in 8:

$$6: [7] \quad 1 + q + q^2 + q^3 + q^4 + q^5 + q^6$$

$$7: [35] \quad q^3 + q^4 + 2q^5 + 3q^6 + 4q^7 + 4q^8 + 5q^9 + 4q^{10} + 4q^{11} + 3q^{12} + 2q^{13} + q^{14} + q^{15}$$

$$8: [21] \quad -1 - q^3 - q^5 - q^6 - q^9 + q^{10} + q^{11} + 2q^{12} + 3q^{13} + 3q^{14} + 3q^{15} + 4q^{16} + 3q^{17} + 2q^{18} + 2q^{19} + q^{20} + q^{21}$$

$$9: [1] \quad q^{22}$$

Neighbours of a point in 9:

$$8: [64] \quad 1 + q + q^2 + 2q^3 + 2q^4 + 3q^5 + 4q^6 + 4q^7 + 4q^8 + 5q^9 + 5q^{10} + 5q^{11} + 5q^{12} + 4q^{13} + 4q^{14} + 4q^{15} + 3q^{16} + 2q^{17} + 2q^{18} + q^{19} + q^{20} + q^{21}$$

$$9: [0] \quad -1 - q^3 - q^5 - q^6 - q^9 + q^{13} + q^{16} + q^{17} + q^{19} + q^{22}$$

$E_{8,8}$

17280 cosets

35 double cosets

Sizes:

0: ()

[1] 1

1: (8)

$$[56] \quad q + q^2 + 2q^3 + 3q^4 + 4q^5 + 5q^6 + 6q^7 + 6q^8 + 6q^9 + 6q^{10} + 5q^{11} + 4q^{12} + 3q^{13} + 2q^{14} + q^{15} + q^{16}$$

2: (856458)

$$[280] \quad q^6 + 2q^7 + 4q^8 + 7q^9 + 11q^{10} + 15q^{11} + 20q^{12} + 24q^{13} + 27q^{14} + 29q^{15} + 29q^{16} + 27q^{17} + 24q^{18} + 20q^{19} + 15q^{20} + 11q^{21} + 7q^{22} + 4q^{23} + 2q^{24} + q^{25}$$

3: (85674563458)

$$[560] \quad q^{11} + 2q^{12} + 5q^{13} + 9q^{14} + 15q^{15} + 22q^{16} + 31q^{17} + 39q^{18} + 47q^{19} + 53q^{20} + 56q^{21} + 56q^{22} + 53q^{23} + 47q^{24} + 39q^{25} + 31q^{26} + 22q^{27} + 15q^{28} + 9q^{29} + 5q^{30} + 2q^{31} + q^{32}$$

4: (856458345623458)

$$[56] \quad q^{15} + 2q^{16} + 3q^{17} + 4q^{18} + 5q^{19} + 6q^{20} + 7q^{21} + 7q^{22} + 6q^{23} + 5q^{24} + 4q^{25} + 3q^{26} + 2q^{27} + q^{28}$$

5: (8564587345623458)

$$[1120] \quad q^{16} + 3q^{17} + 7q^{18} + 14q^{19} + 24q^{20} + 37q^{21} + 53q^{22} + 70q^{23} + 86q^{24} + 100q^{25} + 109q^{26} + 112q^{27} + 109q^{28} + 100q^{29} + 86q^{30} + 70q^{31} + 53q^{32} + 37q^{33} + 24q^{34} + 14q^{35} + 7q^{36} + 3q^{37} + q^{38}$$

6: (856745634585674563458)

$$[28] \quad q^{21} + q^{22} + 2q^{23} + 2q^{24} + 3q^{25} + 3q^{26} + 4q^{27} + 3q^{28} + 3q^{29} + 2q^{30} + 2q^{31} + q^{32} + q^{33}$$

7: (8564583456723456123458)

$$[280] \quad q^{22} + 2q^{23} + 4q^{24} + 7q^{25} + 11q^{26} + 15q^{27} + 20q^{28} + 24q^{29} + 27q^{30} + 29q^{31} + 29q^{32} + 27q^{33} + 24q^{34} + 20q^{35} + 15q^{36} + 11q^{37} + 7q^{38} + 4q^{39} + 2q^{40} + q^{41}$$

8: (8567456345823456123458)

$$[280] \quad q^{22} + 2q^{23} + 4q^{24} + 7q^{25} + 11q^{26} + 15q^{27} + 20q^{28} + 24q^{29} + 27q^{30} + 29q^{31} + 29q^{32} + 27q^{33} + 24q^{34} + 20q^{35} + 15q^{36} + 11q^{37} + 7q^{38} + 4q^{39} + 2q^{40} + q^{41}$$

9: (8567456345856745623458)

$$[840] \quad q^{22} + 3q^{23} + 7q^{24} + 13q^{25} + 22q^{26} + 33q^{27} + 46q^{28} + 59q^{29} + 71q^{30} + 80q^{31} + 85q^{32} + 85q^{33} + 80q^{34} + 71q^{35} + 59q^{36} + 46q^{37} + 33q^{38} + 22q^{39} + 13q^{40} + 7q^{41} + 3q^{42} + q^{43}$$

10: (8567456345856723456123458)

$$[1680] \quad q^{25} + 3q^{26} + 8q^{27} + 16q^{28} + 29q^{29} + 46q^{30} + 68q^{31} + 92q^{32} + 117q^{33} + 139q^{34} + 156q^{35} + 165q^{36} + 165q^{37} + 156q^{38} + 139q^{39} + 117q^{40} + 92q^{41} + 68q^{42} + 46q^{43} + 29q^{44} + 16q^{45} + 8q^{46} + 3q^{47} + q^{48}$$

11: (85645873456234584567345623458)

$$[280] \quad q^{29} + 2q^{30} + 4q^{31} + 7q^{32} + 11q^{33} + 15q^{34} + 20q^{35} + 24q^{36} + 27q^{37} + 29q^{38} + 29q^{39} + 27q^{40} + 24q^{41} + 20q^{42} + 15q^{43} + 11q^{44} + 7q^{45} + 4q^{46} + 2q^{47} + q^{48}$$

12: (856458734562345845673456123458)

$$[1680] \quad q^{30} + 3q^{31} + 8q^{32} + 16q^{33} + 29q^{34} + 46q^{35} + 68q^{36} + 92q^{37} + 117q^{38} + 139q^{39} + 156q^{40} + 165q^{41} + 165q^{42} + 156q^{43} + 139q^{44} + 117q^{45} + 92q^{46} + 68q^{47} + 46q^{48} + 29q^{49} + 16q^{50} + 8q^{51} + 3q^{52} + q^{53}$$

13: (85674563458567456345823456123458)

$$[168] \quad q^{32} + 2q^{33} + 4q^{34} + 6q^{35} + 9q^{36} + 12q^{37} + 15q^{38} + 17q^{39} + 18q^{40} + 18q^{41} + 17q^{42} + 15q^{43} + 12q^{44} + 9q^{45} + 6q^{46} + 4q^{47} + 2q^{48} + q^{49}$$

14: (85645834567234561234585674563458)

$$[168] \quad q^{32} + 2q^{33} + 4q^{34} + 6q^{35} + 9q^{36} + 12q^{37} + 15q^{38} + 17q^{39} + 18q^{40} + 18q^{41} + 17q^{42} + 15q^{43} + 12q^{44} + 9q^{45} + 6q^{46} + 4q^{47} + 2q^{48} + q^{49}$$

15: (85674563458567456234586723456123458)

$$[1120] \quad q^{35} + 3q^{36} + 7q^{37} + 14q^{38} + 24q^{39} + 37q^{40} + 53q^{41} + 70q^{42} + 86q^{43} + 100q^{44} + 109q^{45} + 112q^{46} + 109q^{47} + 100q^{48} + 86q^{49} + 70q^{50} + 53q^{51} + 37q^{52} + 24q^{53} + 14q^{54} + 7q^{55} + 3q^{56} + q^{57}$$

16: (85645834567234561234584567345623458)

$$[1120] \quad q^{35} + 3q^{36} + 7q^{37} + 14q^{38} + 24q^{39} + 37q^{40} + 53q^{41} + 70q^{42} + 86q^{43} + 100q^{44} + 109q^{45} + 112q^{46} + 109q^{47} + 100q^{48} + 86q^{49} + 70q^{50} + 53q^{51} + 37q^{52} + 24q^{53} + 14q^{54} + 7q^{55} + 3q^{56} + q^{57}$$

17: (85674563458234561234583456723456123458)

$$[70] \quad q^{38} + q^{39} + 2q^{40} + 3q^{41} + 5q^{42} + 5q^{43} + 7q^{44} + 7q^{45} + 8q^{46} + 7q^{47} + 7q^{48} + 5q^{49} + 5q^{50} + 3q^{51} + 2q^{52} + q^{53} + q^{54}$$

18: (856745634585672345612345856723456123458)

$$[1680] \quad q^{39} + 3q^{40} + 8q^{41} + 16q^{42} + 29q^{43} + 46q^{44} + 68q^{45} + 92q^{46} + 117q^{47} + 139q^{48} + 156q^{49} + 165q^{50} + 165q^{51} + 156q^{52} + 139q^{53} + 117q^{54} + 92q^{55} + 68q^{56} + 46q^{57} + 29q^{58} + 16q^{59} + 8q^{60} + 3q^{61} + q^{62}$$

19: (856458734562345845673456234584567345623458)

$$[8] \quad q^{42} + q^{43} + q^{44} + q^{45} + q^{46} + q^{47} + q^{48} + q^{49}$$

20: (8564583456723456123458567456345823456123458)

$$[8] \quad q^{43} + q^{44} + q^{45} + q^{46} + q^{47} + q^{48} + q^{49} + q^{50}$$

21: (8564587345623458456734562345845673456123458)

$$[168] \quad q^{43} + 2q^{44} + 4q^{45} + 6q^{46} + 9q^{47} + 12q^{48} + 15q^{49} + 17q^{50} + 18q^{51} + 18q^{52} + 17q^{53} + 15q^{54} + 12q^{55} + 9q^{56} + 6q^{57} + 4q^{58} + 2q^{59} + q^{60}$$

22: (8564587345623458456734561234584567345623458)

$$[168] \quad q^{43} + 2q^{44} + 4q^{45} + 6q^{46} + 9q^{47} + 12q^{48} + 15q^{49} + 17q^{50} + 18q^{51} + 18q^{52} + 17q^{53} + 15q^{54} + 12q^{55} + 9q^{56} + 6q^{57} + 4q^{58} + 2q^{59} + q^{60}$$

23: (85645873456234584567345612345845673456123458)

$$[1680] \quad q^{44} + 3q^{45} + 8q^{46} + 16q^{47} + 29q^{48} + 46q^{49} + 68q^{50} + 92q^{51} + 117q^{52} + 139q^{53} + 156q^{54} + 165q^{55} + 165q^{56} + 156q^{57} + 139q^{58} + 117q^{59} + 92q^{60} + 68q^{61} + 46q^{62} + 29q^{63} + 16q^{64} + 8q^{65} + 3q^{66} + q^{67}$$

24: (85645834567234561234585674563458723456123458)

$$[280] \quad q^{44} + 2q^{45} + 4q^{46} + 7q^{47} + 11q^{48} + 15q^{49} + 20q^{50} + 24q^{51} + 27q^{52} + 29q^{53} + 29q^{54} + 27q^{55} + 24q^{56} + 20q^{57} + 15q^{58} + 11q^{59} + 7q^{60} + 4q^{61} + 2q^{62} + q^{63}$$

25: (8564583456723456123458456734562345856723456123458)

$$[840] \quad q^{49} + 3q^{50} + 7q^{51} + 13q^{52} + 22q^{53} + 33q^{54} + 46q^{55} + 59q^{56} + 71q^{57} + 80q^{58} + 85q^{59} + 85q^{60} + 80q^{61} + 71q^{62} + 59q^{63} + 46q^{64} + 33q^{65} + 22q^{66} + 13q^{67} + 7q^{68} + 3q^{69} + q^{70}$$

26: (856745634585674562345867234561234583456723456123458)

$$[280] \quad q^{51} + 2q^{52} + 4q^{53} + 7q^{54} + 11q^{55} + 15q^{56} + 20q^{57} + 24q^{58} + 27q^{59} + 29q^{60} + 29q^{61} + 27q^{62} + 24q^{63} + 20q^{64} + 15q^{65} + 11q^{66} + 7q^{67} + 4q^{68} + 2q^{69} + q^{70}$$

27: (856745634582345612345834567234561234584567345623458)

$$[280] \quad q^{51} + 2q^{52} + 4q^{53} + 7q^{54} + 11q^{55} + 15q^{56} + 20q^{57} + 24q^{58} + 27q^{59} + 29q^{60} + 29q^{61} + 27q^{62} + 24q^{63} + 20q^{64} + 15q^{65} + 11q^{66} + 7q^{67} + 4q^{68} + 2q^{69} + q^{70}$$

28: (856745634585672345612345856723456123458456723456123458)

$$[1120] \quad q^{54} + 3q^{55} + 7q^{56} + 14q^{57} + 24q^{58} + 37q^{59} + 53q^{60} + 70q^{61} + 86q^{62} + 100q^{63} + 109q^{64} + 112q^{65} + 109q^{66} + 100q^{67} + 86q^{68} + 70q^{69} + 53q^{70} + 37q^{71} + 24q^{72} + 14q^{73} + 7q^{74} + 3q^{75} + q^{76}$$

29: (85645873456234584567345612345845673456234583456723456123458)

$$[28] \quad q^{59} + q^{60} + 2q^{61} + 2q^{62} + 3q^{63} + 3q^{64} + 4q^{65} + 3q^{66} + 3q^{67} + 2q^{68} + 2q^{69} + q^{70} + q^{71}$$

30: (856458734562345845673456123458456734561234583456723456123458)

$$[560] \quad q^{60} + 2q^{61} + 5q^{62} + 9q^{63} + 15q^{64} + 22q^{65} + 31q^{66} + 39q^{67} + 47q^{68} + 53q^{69} + 56q^{70} + 56q^{71} + 53q^{72} + 47q^{73} + 39q^{74} + 31q^{75} + 22q^{76} + 15q^{77} + 9q^{78} + 5q^{79} + 2q^{80} + q^{81}$$

31: (8567456345856745623458672345612345834567234561234584567345623458)

$$[56] \quad q^{64} + 2q^{65} + 3q^{66} + 4q^{67} + 5q^{68} + 6q^{69} + 7q^{70} + 7q^{71} + 6q^{72} + 5q^{73} + 4q^{74} + 3q^{75} + 2q^{76} + q^{77}$$

32:

(8567456345856745623458672345612345834567234561234583456723456123458)

$$[280] \quad q^{67} + 2q^{68} + 4q^{69} + 7q^{70} + 11q^{71} + 15q^{72} + 20q^{73} + 24q^{74} + 27q^{75} + 29q^{76} + 29q^{77} + 27q^{78} + 24q^{79} + 20q^{80} + 15q^{81} + 11q^{82} + 7q^{83} + 4q^{84} + 2q^{85} + q^{86}$$

33:

(85645873456234584567345612345845673456123458345672345612345834567
23456123458)

$$[56] \quad q^{76} + q^{77} + 2q^{78} + 3q^{79} + 4q^{80} + 5q^{81} + 6q^{82} + 6q^{83} + 6q^{84} + 6q^{85} + 5q^{86} + 4q^{87} + 3q^{88} + 2q^{89} + q^{90} + q^{91}$$

34:

(85645873456234584567345612345845673456123458345672345612345834567
234561234583456723456123458)

$$[1] \quad q^{92}$$

Neighbours of a point in 0:

$$1: [56] \quad q + q^2 + 2q^3 + 3q^4 + 4q^5 + 5q^6 + 6q^7 + 6q^8 + 6q^9 + 6q^{10} + 5q^{11} + 4q^{12} + 3q^{13} + 2q^{14} + q^{15} + q^{16}$$

Neighbours of a point in 1:

$$0: [1] \quad 1$$

$$1: [15] \quad -1 + q + q^2 + 2q^3 + 3q^4 + 3q^5 + 3q^6 + 2q^7 + q^8$$

$$2: [30] \quad q^5 + 2q^6 + 4q^7 + 5q^8 + 6q^9 + 5q^{10} + 4q^{11} + 2q^{12} + q^{13}$$

$$3: [10] \quad q^{10} + q^{11} + 2q^{12} + 2q^{13} + 2q^{14} + q^{15} + q^{16}$$

Neighbours of a point in 2:

$$1: [6] \quad 1 + q + 2q^2 + q^3 + q^4$$

$$2: [16] \quad -1 - q^2 + q^3 + 2q^4 + 4q^5 + 4q^6 + 4q^7 + 2q^8 + q^9$$

$$3: [18] \quad q^6 + 2q^7 + 4q^8 + 4q^9 + 4q^{10} + 2q^{11} + q^{12}$$

$$4: [3] \quad q^9 + q^{10} + q^{11}$$

$$5: [12] \quad q^{10} + 2q^{11} + 3q^{12} + 3q^{13} + 2q^{14} + q^{15}$$

$$8: [1] \quad q^{16}$$

Neighbours of a point in 3:

$$1: [1] \quad 1$$

$$2: [9] \quad q + 2q^2 + 3q^3 + 2q^4 + q^5$$

$$3: [15] \quad -1 - q^2 - q^3 + q^4 + 3q^5 + 5q^6 + 5q^7 + 3q^8 + q^9$$

$$5: [18] \quad q^7 + 3q^8 + 5q^9 + 5q^{10} + 3q^{11} + q^{12}$$

$$6: [1] \quad q^{10}$$

$$7: [3] \quad q^{11} + q^{12} + q^{13}$$

$$9: [6] \quad q^{11} + 2q^{12} + 2q^{13} + q^{14}$$

$$10: [3] \quad q^{14} + q^{15} + q^{16}$$

Neighbours of a point in 4:

$$2: [15] \quad 1 + q + 2q^2 + 2q^3 + 3q^4 + 2q^5 + 2q^6 + q^7 + q^8$$

$$4: [6] \quad -1 - q^2 - q^4 + q^5 + q^6 + 2q^7 + q^8 + 2q^9 + q^{10} + q^{11}$$

$$\begin{aligned} 5: [20] & \quad q^4 + q^5 + 2q^6 + 3q^7 + 3q^8 + 3q^9 + 3q^{10} + 2q^{11} + q^{12} + q^{13} \\ 8: [15] & \quad q^8 + q^9 + 2q^{10} + 2q^{11} + 3q^{12} + 2q^{13} + 2q^{14} + q^{15} + q^{16} \end{aligned}$$

Neighbours of a point in 5:

$$\begin{aligned} 2: [3] & \quad 1 + q + q^2 \\ 3: [9] & \quad q^2 + 2q^3 + 3q^4 + 2q^5 + q^6 \\ 4: [1] & \quad q^3 \\ 5: [15] & \quad -1 - q^2 - q^3 + 2q^5 + 4q^6 + 6q^7 + 4q^8 + 2q^9 \\ 7: [3] & \quad q^9 + q^{10} + q^{11} \\ 8: [3] & \quad q^8 + q^9 + q^{10} \\ 9: [9] & \quad q^8 + 2q^9 + 3q^{10} + 2q^{11} + q^{12} \\ 10: [9] & \quad q^{10} + 2q^{11} + 3q^{12} + 2q^{13} + q^{14} \\ 11: [1] & \quad q^{13} \\ 12: [3] & \quad q^{14} + q^{15} + q^{16} \end{aligned}$$

Neighbours of a point in 6:

$$\begin{aligned} 3: [20] & \quad 1 + q + 2q^2 + 3q^3 + 3q^4 + 3q^5 + 3q^6 + 2q^7 + q^8 + q^9 \\ 6: [0] & \quad -1 - q^2 - q^3 + q^7 + q^8 + q^{10} \\ 9: [30] & \quad q^5 + 2q^6 + 3q^7 + 4q^8 + 5q^9 + 5q^{10} + 4q^{11} + 3q^{12} + 2q^{13} + q^{14} \\ 14: [6] & \quad q^{11} + q^{12} + q^{13} + q^{14} + q^{15} + q^{16} \end{aligned}$$

Neighbours of a point in 7:

$$\begin{aligned} 3: [6] & \quad 1 + q + 2q^2 + q^3 + q^4 \\ 5: [12] & \quad q^3 + 2q^4 + 3q^5 + 3q^6 + 2q^7 + q^8 \\ 7: [7] & \quad -1 - q^2 + q^5 + q^6 + 2q^7 + q^8 + 2q^9 + q^{10} + q^{11} \\ 10: [18] & \quad q^6 + 2q^7 + 4q^8 + 4q^9 + 4q^{10} + 2q^{11} + q^{12} \\ 12: [12] & \quad q^{10} + 2q^{11} + 3q^{12} + 3q^{13} + 2q^{14} + q^{15} \\ 17: [1] & \quad q^{16} \end{aligned}$$

Neighbours of a point in 8:

$$\begin{aligned} 2: [1] & \quad 1 \\ 4: [3] & \quad q + q^2 + q^3 \\ 5: [12] & \quad q^2 + 2q^3 + 3q^4 + 3q^5 + 2q^6 + q^7 \\ 8: [12] & \quad -1 - q^2 - q^3 + q^5 + 3q^6 + 4q^7 + 4q^8 + 2q^9 + q^{10} \\ 10: [18] & \quad q^7 + 2q^8 + 4q^9 + 4q^{10} + 4q^{11} + 2q^{12} + q^{13} \\ 13: [6] & \quad q^{10} + q^{11} + 2q^{12} + q^{13} + q^{14} \\ 15: [4] & \quad q^{13} + q^{14} + q^{15} + q^{16} \end{aligned}$$

Neighbours of a point in 9:

$$3: [4] \quad 1 + q + q^2 + q^3$$

- 5: [12] $q^2 + 2q^3 + 3q^4 + 3q^5 + 2q^6 + q^7$
 6: [1] q^4
 9: [13] $-1 - q^2 - q^3 - q^4 + q^5 + 3q^6 + 4q^7 + 4q^8 + 3q^9 + 2q^{10}$
 10: [8] $q^7 + 2q^8 + 2q^9 + 2q^{10} + q^{11}$
 11: [6] $q^9 + q^{10} + 2q^{11} + q^{12} + q^{13}$
 12: [6] $q^{10} + q^{11} + 2q^{12} + q^{13} + q^{14}$
 14: [2] $q^{11} + q^{12}$
 16: [4] $q^{13} + q^{14} + q^{15} + q^{16}$

Neighbours of a point in 10:

- 3: [1] 1
 5: [6] $q + 2q^2 + 2q^3 + q^4$
 7: [3] $q^3 + q^4 + q^5$
 8: [3] $q^4 + q^5 + q^6$
 9: [4] $q^4 + 2q^5 + q^6$
 10: [14] $-1 - q^2 - q^3 - q^4 + 3q^6 + 6q^7 + 5q^8 + 3q^9 + q^{10}$
 12: [12] $q^8 + 3q^9 + 4q^{10} + 3q^{11} + q^{12}$
 13: [1] q^{10}
 14: [1] q^{11}
 15: [6] $q^{11} + 2q^{12} + 2q^{13} + q^{14}$
 16: [2] $q^{12} + q^{13}$
 18: [3] $q^{14} + q^{15} + q^{16}$

Neighbours of a point in 11:

- 5: [4] $1 + q + q^2 + q^3$
 9: [18] $q^2 + 2q^3 + 4q^4 + 4q^5 + 4q^6 + 2q^7 + q^8$
 11: [12] $-1 - q^2 - q^3 - q^4 + 3q^7 + 3q^8 + 4q^9 + 3q^{10} + 2q^{11} + q^{12}$
 12: [6] $q^6 + q^7 + 2q^8 + q^9 + q^{10}$
 16: [12] $q^9 + 2q^{10} + 3q^{11} + 3q^{12} + 2q^{13} + q^{14}$
 19: [1] q^{13}
 22: [3] $q^{14} + q^{15} + q^{16}$

Neighbours of a point in 12:

- 5: [2] $1 + q$
 7: [2] $q^2 + q^3$
 9: [3] $q^2 + q^3 + q^4$
 10: [12] $q^3 + 3q^4 + 4q^5 + 3q^6 + q^7$
 11: [1] q^5

- 12: [13] $-1 - q^2 - q^3 - q^4 - q^5 + 2q^6 + 5q^7 + 6q^8 + 4q^9 + q^{10}$
 15: [6] $q^9 + 2q^{10} + 2q^{11} + q^{12}$
 16: [6] $q^9 + 2q^{10} + 2q^{11} + q^{12}$
 17: [1] q^{10}
 18: [6] $q^{11} + 2q^{12} + 2q^{13} + q^{14}$
 21: [1] q^{13}
 23: [3] $q^{14} + q^{15} + q^{16}$

Neighbours of a point in 13:

- 8: [10] $1 + q + 2q^2 + 2q^3 + 2q^4 + q^5 + q^6$
 10: [10] $q^3 + q^4 + 2q^5 + 2q^6 + 2q^7 + q^8 + q^9$
 13: [10] $-1 - q^2 - q^3 + q^5 + 2q^6 + 3q^7 + 3q^8 + 2q^9 + 2q^{10}$
 15: [20] $q^7 + 2q^8 + 3q^9 + 4q^{10} + 4q^{11} + 3q^{12} + 2q^{13} + q^{14}$
 20: [1] q^{11}
 24: [5] $q^{12} + q^{13} + q^{14} + q^{15} + q^{16}$

Neighbours of a point in 14:

- 6: [1] 1
 9: [10] $q + 2q^2 + 2q^3 + 2q^4 + 2q^5 + q^6$
 10: [10] $q^4 + q^5 + 2q^6 + 2q^7 + 2q^8 + q^9 + q^{10}$
 14: [5] $-1 - q^2 + q^5 + q^6 + 2q^7 + q^8 + q^9 + q^{11}$
 16: [20] $q^6 + 2q^7 + 3q^8 + 4q^9 + 4q^{10} + 3q^{11} + 2q^{12} + q^{13}$
 18: [10] $q^{10} + q^{11} + 2q^{12} + 2q^{13} + 2q^{14} + q^{15} + q^{16}$

Neighbours of a point in 15:

- 8: [1] 1
 10: [9] $q + 2q^2 + 3q^3 + 2q^4 + q^5$
 12: [9] $q^4 + 2q^5 + 3q^6 + 2q^7 + q^8$
 13: [3] $q^4 + q^5 + q^6$
 15: [13] $-1 - q^2 - q^3 - q^4 + q^6 + 4q^7 + 4q^8 + 4q^9 + 3q^{10} + q^{11}$
 18: [9] $q^8 + 2q^9 + 3q^{10} + 2q^{11} + q^{12}$
 21: [3] $q^{11} + q^{12} + q^{13}$
 23: [3] $q^{12} + q^{13} + q^{14}$
 24: [3] $q^{11} + q^{12} + q^{13}$
 25: [3] $q^{14} + q^{15} + q^{16}$

Neighbours of a point in 16:

- 9: [3] $1 + q + q^2$
 10: [3] $q^2 + q^3 + q^4$

- 11: [3] $q^3 + q^4 + q^5$
 12: [9] $q^4 + 2q^5 + 3q^6 + 2q^7 + q^8$
 14: [3] $q^3 + q^4 + q^5$
 16: [13] $-1 - q^2 - q^3 - q^4 + 2q^6 + 4q^7 + 4q^8 + 4q^9 + 2q^{10} + q^{11}$
 18: [9] $q^8 + 2q^9 + 3q^{10} + 2q^{11} + q^{12}$
 22: [3] $q^{10} + q^{11} + q^{12}$
 23: [9] $q^{11} + 2q^{12} + 3q^{13} + 2q^{14} + q^{15}$
 27: [1] q^{16}

Neighbours of a point in 17:

- 7: [4] $1 + q + q^2 + q^3$
 12: [24] $q^2 + 2q^3 + 4q^4 + 5q^5 + 5q^6 + 4q^7 + 2q^8 + q^9$
 17: [0] $-1 - q^2 - q^3 - q^4 - q^5 + q^7 + 2q^8 + q^9 + q^{10}$
 18: [24] $q^7 + 2q^8 + 4q^9 + 5q^{10} + 5q^{11} + 4q^{12} + 2q^{13} + q^{14}$
 26: [4] $q^{13} + q^{14} + q^{15} + q^{16}$

Neighbours of a point in 18:

- 10: [3] $1 + q + q^2$
 12: [6] $q^2 + 2q^3 + 2q^4 + q^5$
 14: [1] q^3
 15: [6] $q^4 + 2q^5 + 2q^6 + q^7$
 16: [6] $q^4 + 2q^5 + 2q^6 + q^7$
 17: [1] q^6
 18: [13] $-1 - q^2 - q^3 - q^4 - q^5 + 4q^7 + 6q^8 + 5q^9 + 3q^{10}$
 23: [12] $q^9 + 3q^{10} + 4q^{11} + 3q^{12} + q^{13}$
 24: [1] q^{11}
 25: [3] $q^{12} + q^{13} + q^{14}$
 26: [2] $q^{13} + q^{14}$
 28: [2] $q^{15} + q^{16}$

Neighbours of a point in 19:

- 11: [35] $1 + q + 2q^2 + 3q^3 + 4q^4 + 4q^5 + 5q^6 + 4q^7 + 4q^8 + 3q^9 + 2q^{10} + q^{11} + q^{12}$
 19: [0] $-1 - q^2 - q^3 - q^4 - q^6 + q^7 + q^9 + q^{10} + q^{11} + q^{13}$
 22: [21] $q^6 + q^7 + 2q^8 + 2q^9 + 3q^{10} + 3q^{11} + 3q^{12} + 2q^{13} + 2q^{14} + q^{15} + q^{16}$

Neighbours of a point in 20:

- 13: [21] $1 + q + 2q^2 + 2q^3 + 3q^4 + 3q^5 + 3q^6 + 2q^7 + 2q^8 + q^9 + q^{10}$
 20: [0] $-1 - q^2 - q^4 + q^7 + q^9 + q^{11}$

$$24: [35] \quad q^4 + q^5 + 2q^6 + 3q^7 + 4q^8 + 4q^9 + 5q^{10} + 4q^{11} + 4q^{12} + 3q^{13} + 2q^{14} + q^{15} + q^{16}$$

Neighbours of a point in 21:

$$\begin{aligned} 12: [10] & \quad 1 + q + 2q^2 + 2q^3 + 2q^4 + q^5 + q^6 \\ 15: [20] & \quad q^3 + 2q^4 + 3q^5 + 4q^6 + 4q^7 + 3q^8 + 2q^9 + q^{10} \\ 21: [5] & \quad -1 - q^2 - q^3 - q^4 - q^6 + q^7 + q^8 + 2q^9 + 2q^{10} + 2q^{11} + q^{12} + q^{13} \\ 23: [10] & \quad q^6 + q^7 + 2q^8 + 2q^9 + 2q^{10} + q^{11} + q^{12} \\ 25: [10] & \quad q^{10} + 2q^{11} + 2q^{12} + 2q^{13} + 2q^{14} + q^{15} \\ 29: [1] & \quad q^{16} \end{aligned}$$

Neighbours of a point in 22:

$$\begin{aligned} 11: [5] & \quad 1 + q + q^2 + q^3 + q^4 \\ 16: [20] & \quad q^2 + 2q^3 + 3q^4 + 4q^5 + 4q^6 + 3q^7 + 2q^8 + q^9 \\ 19: [1] & \quad q^5 \\ 22: [10] & \quad -1 - q^2 - q^3 - q^4 - q^5 + q^6 + 2q^7 + 3q^8 + 3q^9 + 3q^{10} + 2q^{11} + q^{12} \\ 23: [10] & \quad q^7 + q^8 + 2q^9 + 2q^{10} + 2q^{11} + q^{12} + q^{13} \\ 27: [10] & \quad q^{10} + q^{11} + 2q^{12} + 2q^{13} + 2q^{14} + q^{15} + q^{16} \end{aligned}$$

Neighbours of a point in 23:

$$\begin{aligned} 12: [3] & \quad 1 + q + q^2 \\ 15: [2] & \quad q^3 + q^4 \\ 16: [6] & \quad q^2 + 2q^3 + 2q^4 + q^5 \\ 18: [12] & \quad q^4 + 3q^5 + 4q^6 + 3q^7 + q^8 \\ 21: [1] & \quad q^5 \\ 22: [1] & \quad q^6 \\ 23: [14] & \quad -1 - q^2 - q^3 - q^4 - q^5 + 3q^7 + 5q^8 + 6q^9 + 4q^{10} + q^{11} \\ 25: [4] & \quad q^{10} + 2q^{11} + q^{12} \\ 26: [3] & \quad q^{11} + q^{12} + q^{13} \\ 27: [3] & \quad q^{10} + q^{11} + q^{12} \\ 28: [6] & \quad q^{12} + 2q^{13} + 2q^{14} + q^{15} \\ 30: [1] & \quad q^{16} \end{aligned}$$

Neighbours of a point in 24:

$$\begin{aligned} 13: [3] & \quad 1 + q + q^2 \\ 15: [12] & \quad q^2 + 2q^3 + 3q^4 + 3q^5 + 2q^6 + q^7 \\ 18: [6] & \quad q^6 + q^7 + 2q^8 + q^9 + q^{10} \\ 20: [1] & \quad q^3 \\ 24: [12] & \quad -1 - q^2 - q^3 + q^5 + 2q^6 + 4q^7 + 3q^8 + 3q^9 + q^{10} + q^{11} \end{aligned}$$

$$25: [18] \quad q^8 + 2q^9 + 4q^{10} + 4q^{11} + 4q^{12} + 2q^{13} + q^{14}$$

$$28: [4] \quad q^{13} + q^{14} + q^{15} + q^{16}$$

Neighbours of a point in 25:

$$15: [4] \quad 1 + q + q^2 + q^3$$

$$18: [6] \quad q^2 + q^3 + 2q^4 + q^5 + q^6$$

$$21: [2] \quad q^4 + q^5$$

$$23: [8] \quad q^5 + 2q^6 + 2q^7 + 2q^8 + q^9$$

$$24: [6] \quad q^3 + q^4 + 2q^5 + q^6 + q^7$$

$$25: [13] \quad -1 - q^2 - q^3 - q^4 - q^5 + q^6 + 3q^7 + 4q^8 + 4q^9 + 4q^{10} + 2q^{11}$$

$$28: [12] \quad q^9 + 2q^{10} + 3q^{11} + 3q^{12} + 2q^{13} + q^{14}$$

$$29: [1] \quad q^{12}$$

$$30: [4] \quad q^{13} + q^{14} + q^{15} + q^{16}$$

Neighbours of a point in 26:

$$17: [1] \quad 1$$

$$18: [12] \quad q + 2q^2 + 3q^3 + 3q^4 + 2q^5 + q^6$$

$$23: [18] \quad q^4 + 2q^5 + 4q^6 + 4q^7 + 4q^8 + 2q^9 + q^{10}$$

$$26: [7] \quad -1 - q^2 - q^3 - q^4 + 2q^7 + q^8 + 2q^9 + 2q^{10} + 2q^{11} + q^{12} + q^{13}$$

$$28: [12] \quad q^8 + 2q^9 + 3q^{10} + 3q^{11} + 2q^{12} + q^{13}$$

$$30: [6] \quad q^{12} + q^{13} + 2q^{14} + q^{15} + q^{16}$$

Neighbours of a point in 27:

$$16: [4] \quad 1 + q + q^2 + q^3$$

$$22: [6] \quad q^2 + q^3 + 2q^4 + q^5 + q^6$$

$$23: [18] \quad q^3 + 2q^4 + 4q^5 + 4q^6 + 4q^7 + 2q^8 + q^9$$

$$27: [12] \quad -1 - q^2 - q^3 - q^4 - q^5 + 2q^7 + 4q^8 + 4q^9 + 4q^{10} + 2q^{11} + q^{12}$$

$$28: [12] \quad q^9 + 2q^{10} + 3q^{11} + 3q^{12} + 2q^{13} + q^{14}$$

$$31: [3] \quad q^{13} + q^{14} + q^{15}$$

$$32: [1] \quad q^{16}$$

Neighbours of a point in 28:

$$18: [3] \quad 1 + q + q^2$$

$$23: [9] \quad q^2 + 2q^3 + 3q^4 + 2q^5 + q^6$$

$$24: [1] \quad q^3$$

$$25: [9] \quad q^4 + 2q^5 + 3q^6 + 2q^7 + q^8$$

$$26: [3] \quad q^5 + q^6 + q^7$$

$$27: [3] \quad q^6 + q^7 + q^8$$

$$28: [15] \quad -1 - q^2 - q^3 - q^4 - q^5 - q^6 + 2q^7 + 4q^8 + 6q^9 + 5q^{10} + 3q^{11} + q^{12}$$

30: [9] $q^{10} + 2q^{11} + 3q^{12} + 2q^{13} + q^{14}$

31: [1] q^{13}

32: [3] $q^{14} + q^{15} + q^{16}$

Neighbours of a point in 29:

21: [6] $1 + q + q^2 + q^3 + q^4 + q^5$

25: [30] $q^2 + 2q^3 + 3q^4 + 4q^5 + 5q^6 + 5q^7 + 4q^8 + 3q^9 + 2q^{10} + q^{11}$

29: [0] $-1 - q^2 - q^3 - q^4 - q^5 + q^8 + q^9 + q^{10} + q^{11} + q^{12}$

30: [20] $q^7 + q^8 + 2q^9 + 3q^{10} + 3q^{11} + 3q^{12} + 3q^{13} + 2q^{14} + q^{15} + q^{16}$

Neighbours of a point in 30:

23: [3] $1 + q + q^2$

25: [6] $q^2 + 2q^3 + 2q^4 + q^5$

26: [3] $q^3 + q^4 + q^5$

28: [18] $q^4 + 3q^5 + 5q^6 + 5q^7 + 3q^8 + q^9$

29: [1] q^6

30: [15] $-1 - q^2 - q^3 - q^4 - q^5 - q^6 + q^7 + 3q^8 + 5q^9 + 6q^{10} + 4q^{11} + 2q^{12}$

32: [9] $q^{11} + 2q^{12} + 3q^{13} + 2q^{14} + q^{15}$

33: [1] q^{16}

Neighbours of a point in 31:

27: [15] $1 + q + 2q^2 + 2q^3 + 3q^4 + 2q^5 + 2q^6 + q^7 + q^8$

28: [20] $q^3 + q^4 + 2q^5 + 3q^6 + 3q^7 + 3q^8 + 3q^9 + 2q^{10} + q^{11} + q^{12}$

31: [6] $-1 - q^2 - q^3 - q^4 + 2q^7 + q^8 + 2q^9 + 2q^{10} + 2q^{11} + q^{13}$

32: [15] $q^8 + q^9 + 2q^{10} + 2q^{11} + 3q^{12} + 2q^{13} + 2q^{14} + q^{15} + q^{16}$

Neighbours of a point in 32:

27: [1] 1

28: [12] $q + 2q^2 + 3q^3 + 3q^4 + 2q^5 + q^6$

30: [18] $q^4 + 2q^5 + 4q^6 + 4q^7 + 4q^8 + 2q^9 + q^{10}$

31: [3] $q^5 + q^6 + q^7$

32: [16] $-1 - q^2 - q^3 - q^4 - q^5 - q^6 + q^7 + 2q^8 + 4q^9 + 5q^{10} + 5q^{11} + 3q^{12} + 2q^{13}$

33: [6] $q^{12} + q^{13} + 2q^{14} + q^{15} + q^{16}$

Neighbours of a point in 33:

30: [10] $1 + q + 2q^2 + 2q^3 + 2q^4 + q^5 + q^6$

32: [30] $q^3 + 2q^4 + 4q^5 + 5q^6 + 6q^7 + 5q^8 + 4q^9 + 2q^{10} + q^{11}$

33: [15] $-1 - q^2 - q^3 - q^4 - q^5 - q^6 + q^8 + 2q^9 + 4q^{10} + 4q^{11} + 4q^{12} + 3q^{13} + 2q^{14} + q^{15}$

34: [1] q^{16}

Neighbours of a point in 34:

$$\begin{aligned}
 33: [56] \quad & 1 + q + 2q^2 + 3q^3 + 4q^4 + 5q^5 + 6q^6 + 6q^7 + 6q^8 + 6q^9 + 5q^{10} + \\
 & 4q^{11} + 3q^{12} + 2q^{13} + q^{14} + q^{15} \\
 34: [0] \quad & -1 - q^2 - q^3 - q^4 - q^5 - q^6 + q^{10} + q^{11} + q^{12} + q^{13} + q^{14} + q^{16}
 \end{aligned}$$